

Operating Manual

Original operating manual

Datacolor CONDITIONER™

Sample conditioning cabinet
with display controller MB2

9020-0129, 9120-0129 without lights

9020-0190, 9120-0190 with lights

Content

1. SAFETY	6
1.1 Legal considerations	6
1.2 Structure of the safety instructions.....	6
1.2.1 Signal word panel.....	6
1.2.2 Safety alert symbol.....	7
1.2.3 Pictograms.....	7
1.2.4 Word message panel structure	8
1.3 Localization / position of safety labels on the cabinet.....	8
1.4 Type plate	9
1.5 General safety instructions on installing and operating the cabinets	10
1.6 Intended use	12
1.7 Operating instructions	12
1.8 Measures to prevent accidents	13
1.9 Resistance of the humidity sensor against harmful substances.....	14
2. CABINET DESCRIPTION	15
2.1 Cabinet overview.....	16
2.2 Instrument panel	17
2.3 Lateral control panel	17
2.4 Rear view with water connections	18
3. COMPLETENESS OF DELIVERY, TRANSPORTATION, STORAGE, AND INSTALLATION	19
3.1 Unpacking, and checking equipment and completeness of delivery.....	19
3.2 Guidelines for safe lifting and transportation	19
3.3 Storage.....	20
3.4 Location of installation and ambient conditions	21
4. INSTALLATION AND CONNECTIONS	22
4.1 Spacer for wall distance	22
4.2 Wastewater connection.....	23
4.3 Freshwater supply.....	23
4.3.1 Automatic fresh water supply via water pipe.....	24
4.3.2 Manual fresh water supply via external freshwater can (option).....	26
4.4 Optional water treatment system BINDER Pure Aqua Service	26
4.5 Optional external freshwater and wastewater cans	26
4.5.1 Mounting the freshwater can	27
4.5.2 Mounting the wastewater can.....	28
4.5.3 Mounting with wastewater recycling.....	29
4.6 Placement of the light cassettes (cabinet with lights)	30
4.7 Electrical connection	30
4.8 Connection of the optional voltage changer	31
5. FUNCTIONAL OVERVIEW OF THE MB2 CHAMBER CONTROLLER	33
5.1 Operating functions in normal display.....	35
5.2 Display views: Normal display, program display, chart-recorder display	36
5.3 Controller icons overview	37
5.4 Operating modes.....	39
5.5 Controller menu structure	40
5.5.1 Main menu.....	41
5.5.2 "Settings" submenu	42
5.5.3 "Service" submenu	42
5.6 Principle of controller entries.....	43
5.7 Performance during and after power failures.....	43
5.8 Performance when opening the door.....	44

6.	START UP	44
6.1	Turning on the cabinet	44
6.2	Controller settings upon start up	44
6.3	Turning on/off humidity control.....	45
7.	SET-POINT ENTRY IN “FIXED VALUE” OPERATING MODE	46
7.1	Set-point entry for temperature, humidity, light intensity, and fan speed through the “Setpoints” menu	47
7.2	Direct setpoint entry for temperature, humidity, and light intensity via Normal display	48
7.3	Special controller functions via operation lines.....	48
8.	TIMER PROGRAM: STOPWATCH FUNCTION	49
8.1	Starting a timer program	49
8.1.1	Performance during program delay time.....	49
8.2	Stopping a running timer program	50
8.2.1	Pausing a running timer program.....	50
8.2.2	Cancelling a running timer program.....	50
8.3	Performance after the end of the program.....	50
9.	TIME PROGRAMS	51
9.1	Starting an existing time program	51
9.1.1	Performance during program delay time.....	52
9.2	Stopping a running time program.....	52
9.2.1	Pausing a running time program	52
9.2.2	Cancelling a running time program	52
9.3	Performance after the end of the program.....	52
9.4	Creating a new time program.....	53
9.5	Program editor: program management.....	53
9.5.1	Deleting a time program	54
9.6	Section editor: section management	55
9.6.1	Add a new program section.....	56
9.6.2	Copy and insert or replace a program section	56
9.6.3	Deleting a program section	57
9.7	Value entry for a program section.....	58
9.7.1	Section duration.....	58
9.7.2	Set-point ramp and set-point step	59
9.7.3	Special controller functions via operation lines	60
9.7.4	Setpoint entry	61
9.7.5	Tolerance range	61
9.7.6	Repeating one or several sections within a time program	62
9.7.7	Saving the time program	63
10.	WEEK PROGRAMS	64
10.1	Starting an existing week program.....	64
10.2	Cancelling a running week program	64
10.3	Creating a new week program.....	65
10.4	Program editor: program management.....	66
10.4.1	Deleting a week program	67
10.5	Section editor: Section management.....	68
10.5.1	Add a new program section.....	69
10.5.2	Copy and insert or replace a program section	69
10.5.3	Deleting a program section	70
10.6	Value entry for a program section.....	70
10.6.1	Set-point ramp and set-point step modes	70
10.6.2	Weekday.....	71
10.6.3	Start time	71
10.6.4	Setpoint entry	72
10.6.5	Special controller functions via operation lines	72

11. NOTIFICATION AND ALARM FUNCTIONS	73
11.1 Notification and alarm messages overview	73
11.1.1 Notifications	73
11.1.2 Alarm messages	74
11.1.3 Messages concerning the humidity system	74
11.2 State of alarm	75
11.3 Resetting an alarm, list of active alarms	75
11.4 Tolerance range settings	76
11.5 Activating / deactivating the audible alarm (alarm buzzer)	77
12. TEMPERATURE SAFETY DEVICES	77
12.1 Over temperature protective device (class 1)	77
12.2 Overtemperature safety controller class 3.1	77
12.2.1 Safety controller modes	78
12.2.2 Setting the safety controller	78
12.2.3 Message and measures in the state of alarm	79
12.2.4 Function check	79
13. USER MANAGEMENT	80
13.1 Authorization levels and password protection	80
13.2 Log in	83
13.3 Log out	84
13.4 User change	84
13.5 Password assignment and password change	85
13.5.1 Password change	85
13.5.2 Deleting the password for an individual authorization level	87
13.5.3 New password assignment for "service" or "admin" authorization level when the password function was deactivated	88
13.6 Activation code	89
14. GENERAL CONTROLLER SETTINGS	90
14.1 Selecting the controller's menu language	90
14.2 Selecting the temperature unit	90
14.3 Setting date and time	91
14.4 Display configuration	92
14.4.1 Adapting the display parameters	92
14.4.2 Touchscreen calibration	93
14.5 Network and communication	94
14.5.1 Ethernet	94
14.5.2 Web server	95
14.5.3 E-Mail	96
14.6 USB menu	97
15. GENERAL INFORMATION	98
15.1 Service contact page	98
15.2 Current operating parameters	98
15.3 Event list	99
15.4 Counter of operating hours (cabinet with lights)	100
15.5 Technical information on the cabinet	100
16. CHART RECORDER DISPLAY	101
16.1 Views	101
16.1.1 Show and hide legend	101
16.1.2 Switch between legend pages	101
16.1.3 Show and hide specific indications	102
16.1.4 History display	102
16.2 Setting the parameters	105

17. HUMIDIFICATION / DEHUMIDIFICATION SYSTEM	106
17.1 Function of the humidifying and dehumidifying system	108
18. DEFROSTING AT REFRIGERATING OPERATION (CABINET WITHOUT LIGHTS)	109
19. ILLUMINATION SYSTEM (CABINET WITH LIGHTS)	110
20. MAINTENANCE, CLEANING, AND SERVICE	111
20.1 Maintenance intervals, service.....	111
20.2 Replacement of the fluorescent tubes	112
20.3 Cleaning and decontamination	112
20.3.1 Cleaning	113
20.3.2 Decontamination	115
21. DISPOSAL	116
21.1 Disposal of the transport packing	116
21.2 Decommissioning.....	116
21.3 Disposal of the cabinet in the member states of the EU.....	116
21.4 Disposal of the cabinet in non-member states of the EU	117
22. TROUBLESHOOTING	118
23. TECHNICAL DESCRIPTION	120
23.1 Factory calibration and adjustment.....	120
23.2 Over current protection	120
23.3 Definition of usable volume	120
23.4 Technical Data	121
23.5 Equipment	122
23.6 Spare parts (extract)	123
23.7 Dimensions size 115.....	124
24. EU DECLARATION OF CONFORMITY	125



All efforts have been made to ensure the accuracy of the information presented in this format. However, should any errors be detected, Datacolor appreciates your efforts to notify us of these oversights.

Changes are periodically made to this information and are incorporated into forthcoming versions. Datacolor reserves the right to make improvements and/or changes in the product(s) and/or program(s) described in this material at any time.



©2010 Datacolor. Datacolor, and other Datacolor product trademarks are the property of Datacolor.

Dear customer,

For the correct operation of the Datacolor CONDITIONER™ sample conditioning cabinet, it is important that you read this operating manual completely and carefully and observe all instructions as indicated. Failure to read, understand and follow the instructions may result in personal injury. It can also lead to damage to the cabinet and/or poor equipment performance.

1. Safety

This operating manual is part of the components of delivery. Always keep it handy for reference. The device should only be operated by laboratory personnel especially trained for this purpose and familiar with all precautionary measures required for working in a laboratory. Observe the national regulations on minimum age of laboratory personnel. To avoid injuries and damage observe the safety instructions of the operating manual.

	 WARNING
	<p>Failure to observe the safety instructions. Serious injuries and cabinet damage.</p> <ul style="list-style-type: none"> ➤ Observe the safety instructions in this operating manual. ➤ Carefully read the complete operating instructions of the cabinets.

1.1 Legal considerations

This operating manual is for informational purposes only. It contains information for installing, start-up, operation and maintenance of the product. Note: the contents and the product described are subject to change without notice.

Understanding and observing the instructions in this operating manual are prerequisites for hazard-free use and safety during operation and maintenance. In no event shall Datacolor be held liable for any damages, direct or incidental arising out of or related to the use of this manual.

This operating manual cannot cover all conceivable applications. If you would like additional information, or if special problems arise that are not sufficiently addressed in this manual, please ask your dealer or contact us directly by phone at the number located on page one of this manual

Furthermore, we emphasize that the contents of this operating manual are not part of an earlier or existing agreement, description, or legal relationship, nor do they modify such a relationship. All obligations on the part of Datacolor derive from the respective purchase contract, which also contains the entire and exclusively valid statement of warranty administration. The statements in this manual neither augment nor restrict the contractual warranty provisions.

1.2 Structure of the safety instructions

In this operating manual, the following safety definitions and symbols indicate dangerous situations following the harmonization of ISO 3864-2 and ANSI Z535.6.

1.2.1 Signal word panel

Depending on the probability of serious consequences, potential dangers are identified with a signal word, the corresponding safety color, and if appropriate, the safety alert symbol.

 DANGER
<p>Indicates an imminently hazardous situation that, if not avoided, will result in death or serious (irreversible) injury.</p>

 **WARNING**

Indicates a potentially hazardous situation which, if not avoided, could result in death or serious (irreversible) injury.

 **CAUTION**

Indicates a potentially hazardous situation which, if not avoided, may result in moderate or minor (reversible) injury.

CAUTION

Indicates a potentially hazardous situation which, if not avoided, may result in damage to the product and/or its functions or of a property in its proximity.



















1.2.2 Safety alert symbol



Use of the safety alert symbol indicates a **risk of injury**.

Observe all measures that are marked with the safety alert symbol in order to avoid death or injury.

1.2.3 Pictograms

Warning signs			
 Electrical hazard	 Hot surface	 Explosive atmosphere	 Stability hazard
 Lifting hazard	 Scalding hazard	 High humidity	 Danger of frost
 Risk of corrosion and / or chemical burns	 Harmful substances	 Biohazard	 Pollution Hazard
Mandatory action signs			
 Mandatory regulation	 Read operating instructions	 Disconnect the power plug	 Lift with several persons
 Environment protection	 Wear protective gloves	 Wear safety goggles	

Prohibition signs			
			
Do NOT touch	Do NOT spray with water	Do NOT climb	

	Information to be observed in order to ensure optimum function of the product.
---	---









1.2.4 Word message panel structure

<p>Type / cause of hazard.</p> <p>Possible consequences.</p> <ul style="list-style-type: none"> ∅ Instruction how to avoid the hazard: prohibition ➤ Instruction how to avoid the hazard: mandatory action.

Observe all other notes and information not necessarily emphasized in the same way, in order to avoid disruptions that could result in direct or indirect injury or property damage.

1.3 Localization / position of safety labels on the cabinet

The following labels are located on the cabinet:

Pictograms (warning signs)							
	Hot surface (inner glass door above the glass door handle)						
	<table border="1" style="width: 100%;"> <tr> <td style="text-align: center;"></td> <td style="text-align: center;">WARNING</td> <td style="text-align: center;"></td> </tr> <tr> <td colspan="3">Hot Surface. Escape of hot steam. Burning & Scalding Hazard. Access only when cold.</td> </tr> </table>		WARNING		Hot Surface. Escape of hot steam. Burning & Scalding Hazard. Access only when cold.		
	WARNING						
Hot Surface. Escape of hot steam. Burning & Scalding Hazard. Access only when cold.							
	Burning and scalding hazard (cabinet rear)						

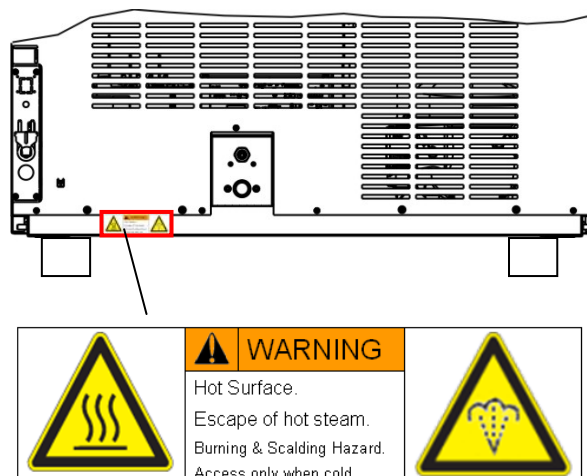

Figure 1: Position of labels on the cabinet rear



Keep safety labels complete and legible.

Replace safety labels that are no longer legible. Contact your local Datacolor service representative for these replacements.

1.4 Type plate

The type plate sticks to the left side of the cabinet, bottom right-hand.







Nominal temp.	70 °C 158 °F	2,00 kW / 8,4 A 200-240 V / 50 Hz	 	Max. operating pressure 15 bar R 134A – 0,180 kg Contains fluorinated greenhouse gases covered by the Kyoto Protocol
IP protection	20	200-240 V / 60 Hz		
Safety device	DIN 12880	2 ~		
Class	3.1			
Art. No.	9020-0129			
Project No.		Datacolor CONDITIONER™		
Built	2017	Sample conditioning cabinet		
		BINDER GmbH Im Mittleren Ösch 5 78532 Tuttlingen / Germany www.binder-world.com		KBF115 - DC Serial No. 0000000000000 Made in Germany

Figure 2: Type plate (example: cabinet without lights)

Indications of the type plate (example)		Information
datacolor		Distributor: Datacolor
BINDER GmbH		Manufacturer: BINDER GmbH
Datacolor CONDITIONER™		Model designation
Sample conditioning cabinet		Device name
Built	2017	Serial no. of the cabinet
Serial No.	00000000000000	Year of construction
Nominal temperature	70 °C / 158 °F	Nominal temperature
IP protection	20	IP type of protection acc. to standard EN 60529
Temp. safety device	DIN 12880	Temperature safety device acc. to standard DIN 12880:2007
Class	3.1	Class of temperature safety device
Art. No.	9020-0129	Art. no. of the cabinet
Project No.	---	Optional: Special application acc. to project no.
2,0 kW		Nominal power
8,4 A		Nominal current
200-240 V / 50 Hz		Nominal voltage range +/-10% at the indicated power frequency
200-240 V / 60 Hz		
2 ~		Current type
Max. operating pressure 15 bar		Max operating pressure in the refrigerating system (15 bar / 218 PSI)
R 134A - 0,180 kg		Refrigerant type and filling weight
Contains fluorinated greenhouse gases covered by the Kyoto Protocol		

Symbol on the type plate	Information
	CE conformity marking
	Electrical and electronic equipment manufactured / placed on the market in the EU after 13 August 2005 and be disposed of in separate collection according to Directive 2012/19/EU on waste electrical and electronic equipment (WEEE).

1.5 General safety instructions on installing and operating the cabinets

With regard to operating the cabinets and to the installation location, please observe the local national safety regulations that apply for laboratories or in a room similar to a laboratory.

Datacolor is only responsible for the safety features of the cabinet provided skilled electricians or qualified personnel authorized by Datacolor perform all maintenance and repair, and if components relating to cabinet safety are replaced in the event of failure with original spare parts.

When the cabinet is installed, operated, cleaned, decontaminated, adjusted or set up incorrectly, there is a risk of malfunction which could cause harm to human beings and material damage to the equipment and samples.



Therefore the cabinet should only be installed, operated, cleaned, decontaminated, adjusted and set up by suitably qualified persons.

- Persons qualified to install, operate, clean, and decontaminate the cabinet only include laboratory personnel who have carefully read the operating manual and are especially trained for this purpose. Observe the national regulations on minimum age of laboratory personnel.
- Persons qualified to repair and adjust the cabinet only include electricians and service engineers authorized by the Datacolor, who have undergone appropriate electrical training and who have carefully read the cabinet service and operating manuals.



To operate the cabinet, use only original Datacolor accessories or accessories from third-party suppliers authorized by Datacolor. The user is responsible for any risk caused by using unauthorized accessories.

	CAUTION
	<p>Danger of overheating. Damage to the cabinet.</p> <ul style="list-style-type: none"> ⊘ Do NOT install the cabinet in unventilated recesses. ➤ Ensure sufficient ventilation for dispersal of the heat.

Do not operate the cabinets in hazardous locations.

	 DANGER
	<p>Explosion hazard. Danger of death.</p> <ul style="list-style-type: none"> ⊘ Do NOT operate the cabinet in potentially explosive areas. ⊘ KEEP explosive dust or air-solvent mixtures AWAY from the cabinet.

The cabinets do not dispose of any measures of explosion protection.

	 DANGER
	<p>Explosion hazard. Danger of death.</p> <ul style="list-style-type: none"> ⊘ Do NOT introduce any substance into the cabinet which is combustible or explosive at working temperature. ⊘ NO explosive dust or air-solvent mixture in the inner chamber.



Any solvent contained in the charging material must not be explosive or inflammable. I.e., irrespective of the solvent concentration in the steam room, NO explosive mixture with air must form. The temperature inside the chamber must lie below the flash point or below the sublimation point of the charging material. Familiarize yourself with the physical and chemical properties of the charging material, as well as the contained moisture constituent and its behavior with the addition of heat energy and humidity.



Familiarize yourself with any potential health risks caused by the charging material, the contained moisture constituent or by reaction products that may arise during the temperature process. Take adequate measures to exclude such risks prior to putting the cabinet into operation.

	 DANGER
	<p>Electrical hazard. Danger of death.</p> <p>∅ The cabinet must NOT become wet during operation or maintenance.</p>

The cabinets were produced in accordance with VDE regulations and were routinely tested in accordance to VDE 0411-1 (IEC 61010-1).

During and shortly after operation, the temperature of the inner surfaces almost equals the set-point.

	 CAUTION
	<p>The glass doors, the glass door handles, the inner chamber, and the light cassettes (cabinet with lights) will become hot during operation.</p> <p>Danger of burning.</p> <p>∅ Do NOT touch the glass doors, the inner surfaces, the light cassettes or the charging material during operation.</p>

 	 WARNING
	<p>Stability hazard. Danger of injury. Damage to the cabinet and the charging material. Housing cover breakaway.</p> <p>∅ Do NOT climb on the lower housing cover.</p> <p>∅ Do NOT load the lower housing cover and the door with heavy objects while the cabinet door is open.</p>



1.6 Intended use

Datacolor CONDITIONER™ sample conditioning cabinets are suitable for exact conditioning of harmless materials. A mixture of any component of the charging material with air must NOT be explosive. The operating temperature must lie below the flash point or below the sublimation point of the charging material. Any component of the charging material must NOT be able to release toxic gases.

Other applications are not approved.

The cabinets are not classified as medical devices as defined by the Medical Device Directive 93/42/EEC.

	Following the instructions in this operating manual and conducting regular maintenance work (chap. 20) are part of the intended use.
---	--

 	<div style="background-color: red; color: white; padding: 5px; text-align: center;">  DANGER </div> <p>Explosion or implosion hazard.</p> <p>Danger of poisoning.</p> <p>Danger of death.</p> <ul style="list-style-type: none"> ⊘ Do NOT introduce any substance combustible or explosive at working temperature into the cabinet, in particular no energy sources such as batteries or lithium-ion batteries. ⊘ NO explosive dust or air-solvent mixture in the inner chamber. ⊘ Do NOT introduce any substance which could lead to release of toxic gases.
--	---

	The charging material shall not contain any corrosive ingredients that may damage the machine components made of stainless steel, aluminum, and copper. Such ingredients include in particular acids and halides. Any corrosive damage caused by such ingredients is excluded from liability by Datacolor.
---	--

	WARNING: If customer should use a cabinet running in non-supervised continuous operation, we strongly recommend in case of inclusion of irrecoverable specimen or samples to split such specimen or samples and store them in at least two cabinets, if this is feasible.
---	--

In case of foreseeable use of the cabinet there is no risk for the user through the integration of the cabinet into systems or by special environmental or operating conditions in the sense of EN 61010-1:2010. For this, the intended use of the cabinet and all its connections must be observed.

1.7 Operating instructions

Depending on the application and location of the cabinet, the operator of the cabinet must provide the relevant information for safe operation of the cabinet in a set of operating instructions.

	Keep these operating instructions with the cabinet at all times in a place where they are clearly visible. They must be comprehensible and written in the language of the employees.
---	--

1.8 Measures to prevent accidents

The operator of the cabinet must observe the following rule: "Betreiben von Arbeitsmitteln. Betreiben von Kälteanlagen, Wärmepumpen und Kühleinrichtungen" (Operation of work equipment. Operation of refrigeration systems, heat pumps and refrigeration equipment) (GUV-R 500 chap. 2.35) (for Germany).

The manufacturer took the following measures to prevent ignition and explosions:

- **Indications on the type plate**

See operating manual chap. 1.4.

- **Operating manual**

An operating manual is available for each cabinet.

- **Overtemperature monitoring**

The cabinet is equipped with a temperature display, which can be read from outside.

The cabinet is equipped with an additional safety controller (temperature safety device class 3.1 acc. to DIN 12880:2007). Visual and audible (buzzer) signals indicate temperature exceeding.

- **Safety, measurement, and control equipment**

The safety, measuring, and control equipment is easily accessible.

- **Electrostatic charge**

The interior parts are grounded.

- **Non-ionizing radiation**

Non-ionizing radiation is not intentionally produced, but released only for technical reasons by electrical equipment (e.g. electric motors, power cables, solenoids). The machine has no permanent magnets. If persons with active implants (e.g. pacemakers, defibrillators) keep a safe distance (distance of field source to implant) of 30 cm, an influence of these implants can be excluded with high probability.

- **Protection against touchable surfaces**

Tested according to EN ISO 13732-1:2008.

- **Floors**

See operating manual chap. 3.4 for correct installation

- **Cleaning**

See operating manual chap. 20.3.

- **Examinations**

The chamber has been inspected by the "Deutsche Gesetzliche Unfallversicherung e.V. (DGUV) (German Social Accident Insurance (DGUV))" (German Social Accident Insurance (DGUV), Testing and Certification Body for Foodstuffs and Packaging Industry in DGUV Test).

1.9 Resistance of the humidity sensor against harmful substances

The following list of harmful substances refers only to the humidity sensor and does not include any other materials incorporated in the cabinet or prohibited substances in relation to explosion protection.

Some gases - especially clean gases - do not have any influence on the humidity sensor. Others do have a very small influence, whereas others may influence the sensor to a larger extent.

- The following gases do not influence the sensor and the humidity measurement: Argon (Ar), carbon dioxide (CO₂), helium (He), hydrogen (H₂), neon (Ne), nitrogen (N₂), nitrous oxide (N₂O), oxygen (O₂)
- The following gases do not or to a minor extent influence the sensor and the humidity measurement: Butane (C₄H₁₀), ethane (C₂H₆), methane (CH₄), natural gas propane (C₃H₈)
- The following gases do not, or to a minor extent influence the sensor and the humidity measurement, provided that the indicated loads are not exceeded:

		Maximum work place threshold limit value		Tolerated concentration with permanent load	
Substance	Formula	ppm	mg/m ³	ppm	mg/m ³
Ammonia	NH ₃	20	14	5500	4000
Acetone	CH ₃ COCH ₃	500	1200	3300	8000
Benzene		300	1200		150000
Chlorine	Cl ₂	0.5	1.5	0.7	2
Acetic acid	CH ₃ COOH	10	25	800	2000
Ethyl acetate	CH ₃ COOC ₂ H ₅	400	1400	4000	15000
Ethanol	C ₂ H ₅ OH	500	960	3500	6000
Ethylene glycol	HOCH ₂ CH ₂ OH	10	26	1200	3000
Formaldehyde	HCHO	0.3	0.37	2400	3000
Isopropanol	(CH ₃) ₂ CHOH	200	500	4800	12000
Methanol	CH ₃ OH	200	260	3500	6000
Methyl ethyl ketone	C ₂ H ₅ COCH ₃	200	590	3300	8000
Ozone	O ₃	0.1	0.2	0.5	1
Hydrochloric acid	HCl	2	3	300	500
Hydrogen sulphide	H ₂ S	10	15	350	500
Nitrogen oxides	NO _x	5	9	5	9
Sulphur dioxide	SO ₂	5	13	5	13
Toluol	C ₆ H ₅ CH ₃	100	380	1300	5000
Xylene	C ₆ H ₄ (CH ₃) ₂	100	440	1300	5000

These values are to be considered as approximate values. The sensor resistance largely depends on the temperature and humidity conditions during the time of exposure to harmful substances. Avoid simultaneous condensation. Tolerated error of measurement: ± 2 %r.H. The maximum work place threshold limit value is one that can be regarded as harmless for humans.

- Vapors of oil and fat are dangerous for the sensor because they may condensate at the sensor and thus prevent its function (insulating layer). For similar reasons it is not possible to measure smoke gases.

2. Cabinet description

The Datacolor CONDITIONER™ sample conditioning cabinet is equipped with a multifunctional micro-processor display controller with 2-channel technology for temperature and humidity plus a digital display accurate to one-tenth of a degree resp. 0.1% r.H. With its comprehensive program control functions, the display program controller MB2 permits the high precision performance of temperature and humidity cycles.

The sample conditioning cabinet with multifunctional microprocessor display controller MB2 is available in two different types:

- without light unit
- with light unit

The sample conditioning cabinet is designed for exact conditioning of harmless materials such as paper, textiles, plastics, building materials, to condition the samples at fixed temperature and humidity, so as ensure no change in color of the samples occurs due to varying temperature and humidity

The APT.line™ preheating chamber system guarantees high level of spatial and time-based temperature precision, thanks to the direct and distributed air circulation into the interior. The fan supports exact attainment and maintenance of the desired temperature accuracy. Furthermore, it permits simulating exactly and over long periods constant conditions for other applications such as sample conditioning for material testing of paper, textiles, plastics, building materials, etc.

A resistance humidifying system humidifies the air. For this purpose, use deionized (demineralized) water. The option BINDER Pure Aqua Service allows using the cabinet with any degree of water hardness.

The cabinet with lights unit is equipped with “Bio Vital” fluorescent tubes installed in two light cassettes. They illuminate very homogeneously the racks below them. Both light cassettes are permanently connected. The cable length permits easily removal to replace the fluorescent tubes. Control is effected via the MB2 controller. Light is dimmable in 1% steps.

The inner chamber, the pre-heating chamber and the interior side of the doors are all made of stainless steel V2A (German material no. 1.4301, US equivalent AISI 304). The housing is RAL 7035 powder-coated. All corners and edges are also completely coated.

The inner chamber is closed by a glass door that enables the samples to be viewed for a short time without disturbing the climate in the inner chamber.

All cabinet functions are easy and comfortable to use thanks to their clear arrangement. Major features are easy cleaning of all cabinet parts and avoidance of undesired contamination.

The efficient program controller is equipped with a multitude of operating functions, in addition to recorder and alarm functions. Programming of test cycles is easily accomplished via the modern MB2 touch screen controller. The cabinet comes equipped with an Ethernet serial interface for computer communication. In addition, the BINDER communication software APT-COM™ 3 permits networking up to 30 chambers and connecting them to a PC for controlling and programming, as well as recording and representing temperature and humidity data. For further options, see chap. 23.5.

The cabinet is equipped with two safety devices to protect the unit, its environment and the samples inside from forbidden temperature excesses:

- Electric safety controller

The sample conditioning cabinet is equipped with an electric over temperature safety device class 3.1 acc. to DIN 12880:2007. It is called a “safety controller”. It serves to protect the charging material against extensive high temperatures. The safety controller is electrically independent from the main temperature controller and takes over control when a selectable set point is reached.

- Temperature fuse

The sample conditioning cabinet is equipped with a temperature fuse, class 1 acc. to DIN 12880:2007. It serves to protect the unit and prevents danger caused by considerable defects. If a temperature of about 110 °C is reached, the temperature fuse switches off the unit permanently.

	Temperature range	Humidity range
Cabinet without lights	0 °C / 32 °F up to 70 °C / 158 °F	10% r.H. to 80% r.H.
Cabinet with lights	0 °C / 32 °F up to 50 °C / 122 °F	10% r.H. to 70% r.H.

For the control ranges of temperature and humidity, see climatic diagram (chap. 17).

Standard temperature and humidity settings for sample conditioning are typically 21 °C and 65 % r.H.

2.1 Cabinet overview

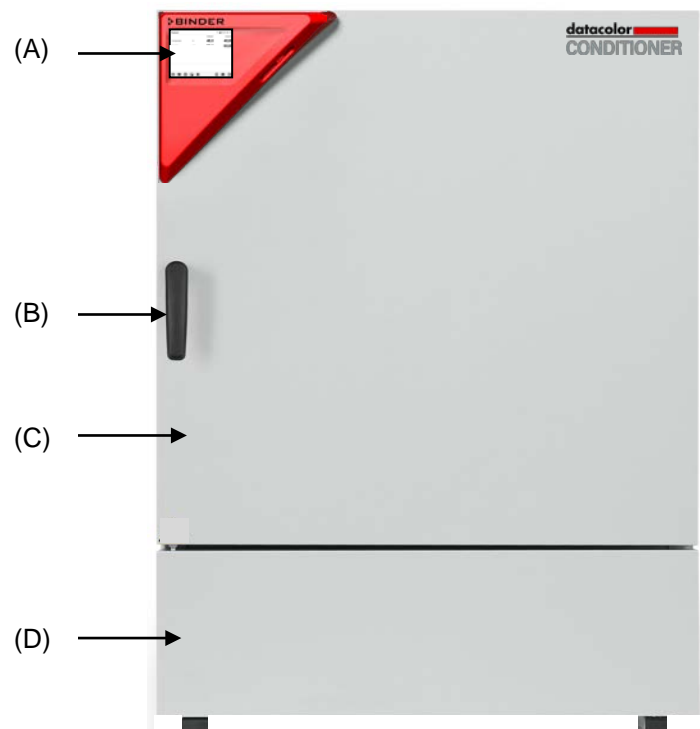

Figure 3: Datacolor CONDITIONER™ sample conditioning cabinet

- (A) Instrument box
- (B) Door handle
- (C) Outer door
- (D) Lower front cover: refrigerating machine and humidity generation module

2.2 Instrument panel

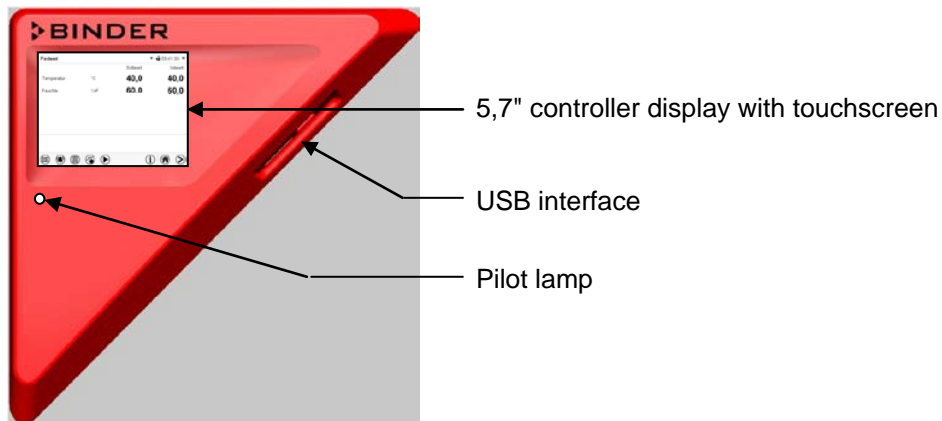

Figure 4: Instrument panel with MB2 program controller and USB interface

2.3 Lateral control panel

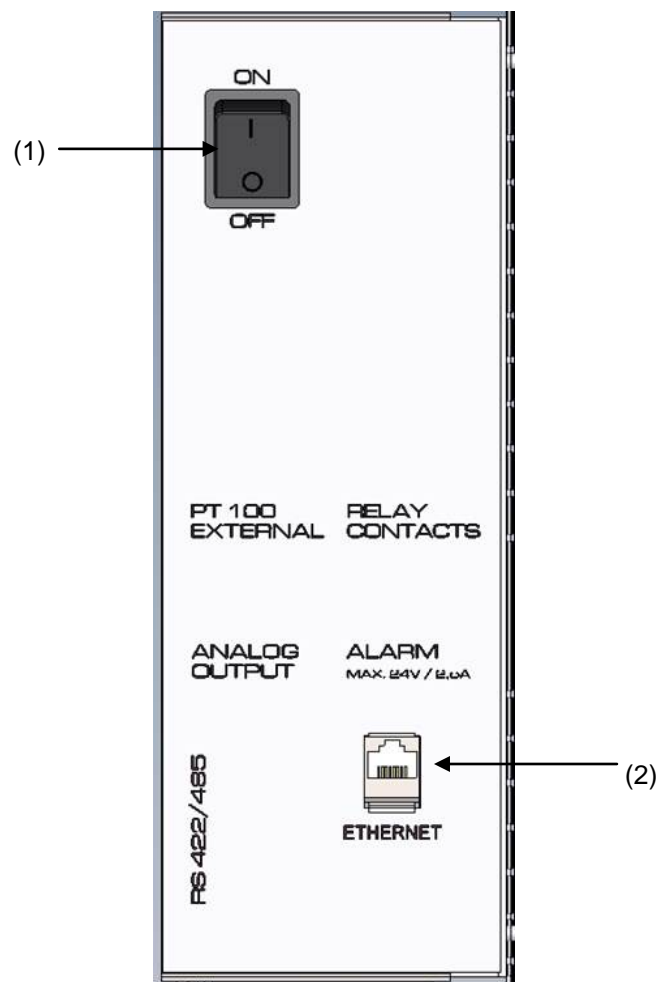

Figure 5: Lateral control panels at the right side of the refrigerating / humidity generation module

- (1) Main power switch
- (2) Ethernet interface

2.4 Rear view with water connections

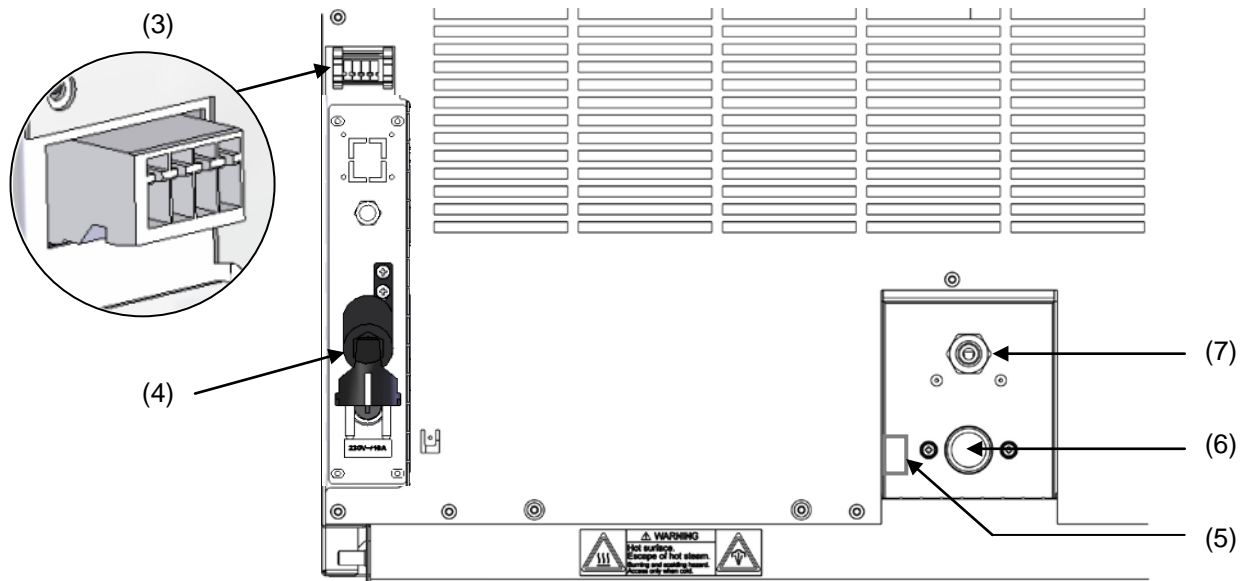

Figure 6: Water connections on the cabinet rear

- (3) Socket for optional freshwater can (chap. 4.5)
- (4) Power cable
- (5) Purging outlet for humidifying module – for service purpose only
- (6) Freshwater connection "IN" with screw thread $\frac{3}{4}$ " for hose $\frac{1}{2}$ ", with union nut
- (7) Wastewater connection "OUT" with hose olive for hose $\frac{1}{2}$ "





3. Completeness of delivery, transportation, storage, and installation

3.1 Unpacking, and checking equipment and completeness of delivery

After unpacking, please check the cabinet and its optional accessories, if any, based on the delivery receipt for completeness and for transportation damage. Inform the carrier immediately if transportation damage has occurred.

The final tests of the manufacturer may have caused traces of the shelves on the inner surfaces. This has no impact on the function and performance of the cabinet.

Please remove any transportation protection devices and adhesives in/on the cabinet and on the doors and remove the operating manuals and accessory equipment.





  	 CAUTION
	<p>Sliding or tilting of the cabinet. Damage to the cabinet. Risk of injury by lifting heavy loads.</p> <ul style="list-style-type: none"> Ø Do NOT lift or transport the cabinet using the door, the handle, or the lower housing. ➤ Lift the cabinet from the pallet at the four lower corners with the aid of four people

If you need to return the cabinet, please use the original packing and observe the guidelines for safe lifting and transportation (chap. 3.2).

For disposal of the transport packing, see chap. 21.1.

3.2 Guidelines for safe lifting and transportation

After operation, please observe the guidelines for temporarily decommissioning the cabinet (chap. 21.2).

  	 CAUTION
	<p>Sliding or tilting of the cabinet. Damage to the cabinet. Risk of injury by lifting heavy loads.</p> <ul style="list-style-type: none"> ➤ Transport the cabinet in its original packaging only. ➤ For moving or shipping, secure the cabinet with transport straps. Ø Do NOT lift or transport the cabinet using the door, the handle, or the lower housing. ➤ Lift the cabinet at the four lower corners with the aid of 4 people

You can order transport packing for moving or shipping purposes from your local Datacolor service representative.

Permissible ambient temperature range during transport:

- If the steam humidifying system has NOT been emptied: +3 °C / 37.4 °F to +60 °C / 140 °F.
- After your local Datacolor service representative has emptied the steam humidifying system: -10 °C / 14 °F to +60 °C / 140 °F.

At temperatures below +3 °C / 37.4 °F, water must be completely removed from the humidifying system.

	CAUTION
	<p>Transport below +3 °C / 37.4 °F with filled steam humidifying system.</p> <p>Freezing in the steam generator.</p> <p>Damage to the cabinet.</p> <p>➤ Contact your local Datacolor service representative before any transportation below +3 °C / 37.4 °F.</p>

3.3 Storage

Intermediate storage of the cabinet is possible in a closed and dry room. Observe the guidelines for temporary decommissioning (chap. 21.2).

Permissible ambient temperature range during storage:

- If the steam humidifying system has NOT been emptied: +3 °C / 37.4 °F to +60 °C / 140 °F.
- After your local Datacolor service representative has emptied the steam humidifying system: -10 °C / 14 °F to +60 °C / 140 °F

With temperatures below +3 °C / 37.4 °F, water must be completely removed from the humidifying system.

	CAUTION
	<p>Storage below +3 °C / 37.4 °F with filled steam humidifying system.</p> <p>Freezing in the steam generator.</p> <p>Damage to the cabinet.</p> <p>➤ Contact your local Datacolor service representative before any transportation below +3 °C / 37.4 °F.</p>

Permissible ambient humidity: max. 70 % r.H., non-condensing

	CAUTION
	<p>Condensation by excess humidity.</p> <p>Danger of corrosion on the housing after operating at humidity values > 70 % r.H. for a long period.</p> <p>➤ Dry the cabinet completely before shut-down:</p> <ul style="list-style-type: none"> • Set the humidity to 0 % r.H. To enable dehumidification, the humidifying and dehumidifying system must be activated (deactivated operation line "Humidity off", chap. 7.3 and setting "Control on", chap. 6.3). • Set the temperature set point to 60 °C / 140 °F for approx. 2 hours (Manual mode). • Only then, shut down the cabinet at the main power switch (1) and close the tap of the water supply.

When after storage in a cold location you transfer the cabinet to its warmer installation site, condensation may form. Before start-up, wait at least one hour until the cabinet has attained ambient temperature and is completely dry.

3.4 Location of installation and ambient conditions

Set up the cabinet on a flat, even surface, and in a well-ventilated, dry location and align it using a spirit level. The site of installation must be capable of supporting the cabinet's weight (see technical data, chap. 23.4). The cabinets are designed for setting up inside a building (indoor use).

	CAUTION
	<p>Danger of overheating. Damage to the cabinet.</p> <ul style="list-style-type: none"> ∅ Do NOT set up cabinet in non-ventilated recesses. ➤ Ensure sufficient ventilation for dispersal of the heat.

- **Permissible ambient temperature range during operation:** +18 °C / 64.4 °F to +32 °C / 89.6 °F. At elevated ambient temperature values, fluctuations in temperature can occur.

	<p>The ambient temperature should not be substantially higher than the indicated ambient temperature of +22 °C +/- 3 °C / 71.6 °F ± 5.4 °F to which the specified technical data relate. Deviations from the indicated data are possible for other ambient conditions. Lower values of the temperature range indicated in the technical data are valid at an ambient temperature of max. 25 °C / 77 °F.</p>
---	---

	<p>With each degree of ambient temperature >25 °C / 77 °F, the refrigeration power decreases by 1.5 K.</p>
--	---

- **Permissible ambient humidity:** 70 % r.H. max., non-condensing

When operating the cabinet at temperature set-points below ambient temperature, high ambient humidity may lead to condensation on the cabinet.

- Installation height: max. 2000 m / 6562 ft. above sea level.

A water tap (1 bar to 10 bar) is necessary for the installation of the humidification system (chap. 4.3). If no suitable in-house water connection is available, you can manually supply water by filling the freshwater can (option, chap. 4.5).

	<p>To avoid any possible water damage, provide a floor drain at the location of the device. Select a suitable installation site to avoid any consequential damage by splashing water.</p>
---	---

When placing several cabinets of the same size side by side, maintain a minimum distance of 250 mm / 9.84 in between each cabinet. Wall distances: rear 100 mm / 3.9 in, sides 160 mm / 6.29 in. Spacing above the cabinet of at least 100 mm / 3.9 in must also be accounted for.

	CAUTION
	<p>Danger by stacking. Damage to the cabinets.</p> <ul style="list-style-type: none"> ∅ Do NOT place the cabinets on top of each other.



To completely separate the cabinet from the power supply, you must disconnect the power plug. Install the cabinet in a way that the power plug is easily accessible and can be easily pulled in case of danger.

For the user there is no risk of temporary overvoltages in the sense of EN 61010-1:2010.

With an increased amount of dust in the ambient air, clean the condenser fan (by suction or blowing) several times a year.

Avoid any conductive dust in the ambience according to the cabinet layout complying with pollution degree 2 (IEC 61010-1).

Do not install or operate the cabinet in potentially explosive areas.

	 DANGER
	<p>Explosion hazard. Danger of death.</p> <ul style="list-style-type: none"> ⊘ Do NOT operate the cabinet in potentially explosive areas. ➤ KEEP explosive dust or air-solvent mixtures AWAY from the vicinity of the cabinet.

After turning off the cabinet, you must close the tap of the water supply. Install the cabinet in a way that the freshwater supply is easily accessible.

In case of a prolonged temporal decommissioning: Leave the cabinet door open or remove the access port plugs.

4. Installation and connections

4.1 Spacer for wall distance

Please fix both spacers with the supplied screws at the cabinet rear. This serves to ensure the prescribed minimum distance to the rear wall of 100 mm / 3.94 in.



Figure 7: Spacer for wall distance

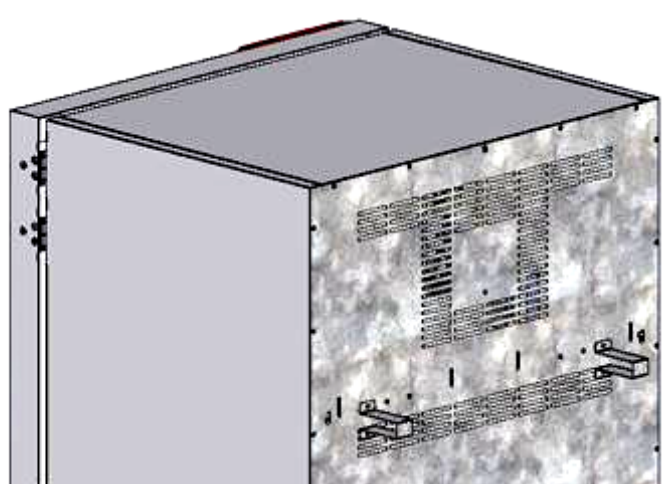



Figure 8: Cabinet rear with mounted spacers

4.2 Wastewater connection

Fasten the wastewater hose to the wastewater connection "OUT" (7) on the rear of the cabinet (olive \varnothing 14 mm). Observe the following points:

- You can use a part of the supplied water hose as a drainage hose. In case another hose is used, it has to be permanently resistant against at least 95 °C / 203 °F.
- Mount the wastewater hose with a maximum positive inclination of 1 m and a maximum total length of 3 m.
- Protect the cabinet end of the drainage hose with one of the supplied hose clamps.
- Reliably prevent sucking back of wastewater. The end of the wastewater hose must not be immersed in liquids. This can be ensured e.g., by free discharge.

	Waste water is collected in an internal can with a volume of approx. 0.5 liters. It is pumped off only when required, thus there is no continuous waste water flow.
---	---

	Protect the waste water supply with the supplied hose clamps.
---	---

4.3 Freshwater supply

	Connect the waste water pipe before connecting the cabinet to a freshwater pipe or filling the freshwater can (option, chap. 4.5).
--	--

You can supply the cabinet with freshwater via a water pipe or by manually filling a freshwater can (option, chap. 4.5).

	Water intake temperature NOT below +5 °C / 41 °F and not exceeding 40 °C / 104 °F.
---	--

	CAUTION
	<p>Calcification of the humidifying system. Damage to the cabinet.</p> <p>➤ Operate the cabinet with deionized (demineralized) water only.</p>

Types of suitable water quality:

- Deionized water from a water treatment installation already existing at the customer's site. Conductivity from 1 μ S/cm up to a maximum of 20 μ S/cm. (Water, which is in equilibrium with the CO₂ in the air, and has a conductivity below 1 μ S/cm (ultrapure water), may cause acid corrosion due to its low pH.)
- Water treated by the optional water treatment system BINDER Pure Aqua Service (disposable system). A reusable measuring equipment to assess the water quality is included (chap. 4.4).

	<p>The manufacturer is NOT responsible for the water quality at the user's site.</p> <p>Any problems and malfunctions that might arise following use of water of deviating quality is excluded from liability by the manufacturer.</p> <p>The warranty becomes void in the event of use of water of deviating quality.</p>
---	--

4.3.1 Automatic fresh water supply via water pipe





An enclosure inside the cabinet contains the connection kit for freshwater and wastewater. Install the freshwater connection using either the enclosed water hose or another pressure-resistant one. To accomplish this, remove the cover of the freshwater connection "IN" (6) on the rear of the cabinet. Protect both ends of the hose with two of the four supplied hose clamps.

Before turning on the cabinet, check the connection for leaks. Water supply is automatically effected via the freshwater connection "IN" (6).

	As the appliance only lets in water when required, there is no continuous water flow.
---	---

	<ul style="list-style-type: none"> • Supply pressure 1 to 10 bar when connecting to a water pipe • Water type: deionized (demineralized) water • Water intake temperature NOT below +5 °C / 41 °F and not exceeding 40 °C / 104 °F. • The water intake should be provided with a shut-off slide or water-tap. • For the water supply, fix the delivered adapter with hose olive on the thread at the rear of the cabinet. • Protect the water supply at one side with the supplied hose clamp.
---	--

The **connection kit** for connecting the cabinet to the water main enclosed with the cabinet includes a protective device against flooding caused by burst water hoses. Items supplied:

Hose burst protection device.	
2 hose nozzles with screwing	
4 hose clamps	
<p>6m water hose (PVC black, 12 mm (1/2") inner diameter), which should be cut into 2 accordingly, for the feed hose and drain.</p> <p>Pressure-resistant up to 10bar, heat resistant up to 95 °C / 203 °F.</p>	

Assembly:

Screw the hose burst protection device onto a water tap with a G $\frac{3}{4}$ inch right turning thread connection. The connection is self-sealing. Establish the connection between the safety kit and the cabinet with a part of the supplied hose. Protect both ends of the hose by the supplied hose clamps.

We recommend connecting the hose as the last step in order to avoid twisting the hose while screwing on the safety kit.

Open the water tap slowly in order to avoid actuating the hose burst protection device.

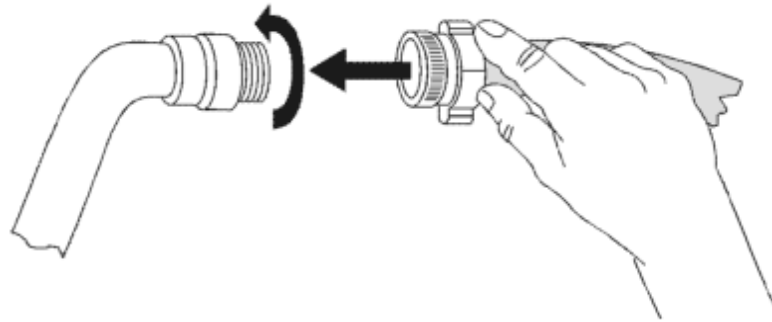

Figure 9: Assembly of the connection kit

Protection principle of the hose burst protection device:

Whenever a strong water flow of about 18 l / min. occurs, e.g. caused by a burst water hose, a valve automatically cuts off the water supply, which can be heard as a clicking noise. The water supply now remains shut until it is manually released.

Release of the reflux protection device:

In case the burst protection device has interrupted the water supply, first find the reason and remove it as necessary. Close the water tap. Release the valve by a half left-turn of the upper knurled part. You can hear the release of the valve as a clicking noise. Tighten the burst protection device against the water tap by a right turn. Open the water tap slowly afterwards.

Maintenance of the assembly of the hose burst protection device:

Calcification can impair valve function. We recommend an annual inspection by a skilled plumber. The plumber should demount the safety kit to check the valve by hand for function, calcification or blockage.

	CAUTION
	<p>Danger of calcification. Impairment of valve function.</p> <ul style="list-style-type: none"> ➤ Have a plumber inspect the valve annually. ➤ Remove calcifications by citric acid or acetic acid solutions. ➤ Continue by testing the function and tightness of the mounted cabinet

Check: Quickly open the water tap while there is no cabinet connected – the valve should cut off the water flux without any delay.

4.3.2 Manual fresh water supply via external freshwater can (option)

If no house water connection with suitable water is available, you can manually supply water by filling a freshwater can (volume: 20 liters / 0.71 cu.ft), which is part of the option “External freshwater and wastewater cans” (chap. 4.5). You can attach the freshwater can on the rear of the cabinet or place it next to the cabinet.

	To guarantee humidification during 24 hours even at high humidity set-points with manual water supply, we recommend filling the freshwater can (option) daily at the end of the day.
---	--

4.4 Optional water treatment system BINDER Pure Aqua Service

The optional water treatment system (disposable unit) is available to treat tap water. The lifetime of the unit depends on water quality and the amount of treated water used. The measuring equipment to assess the water quality is reusable.

	For detailed information on installing and operating the water treatment system BINDER Pure Aqua Service, please refer to the operating manual Art. No. 7001-0269, coming with BINDER Pure Aqua Service.
---	--

4.5 Optional external freshwater and wastewater cans

If no suitable in-house water connection is available, you can manually supply water by filling the optional external freshwater can. There is an additional external water can for the waste water. Volume: 20 liters / 0.71 cu.ft.

The cans are placed in holding devices. You can affix them directly at the rear of the cabinet or place them next to the cabinet.

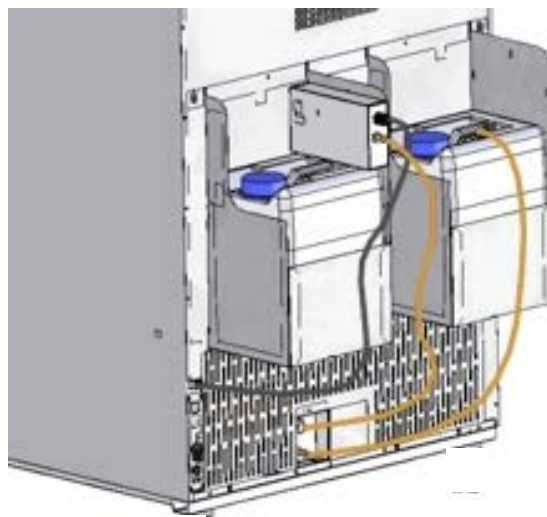

Figure 10: Cabinet rear view with installed external water cans (option)

4.5.1 Mounting the freshwater can

(1) Fixing (if required)

Hang the can with its holding device on its 4 carriers. You can install it either at the left or the right side.

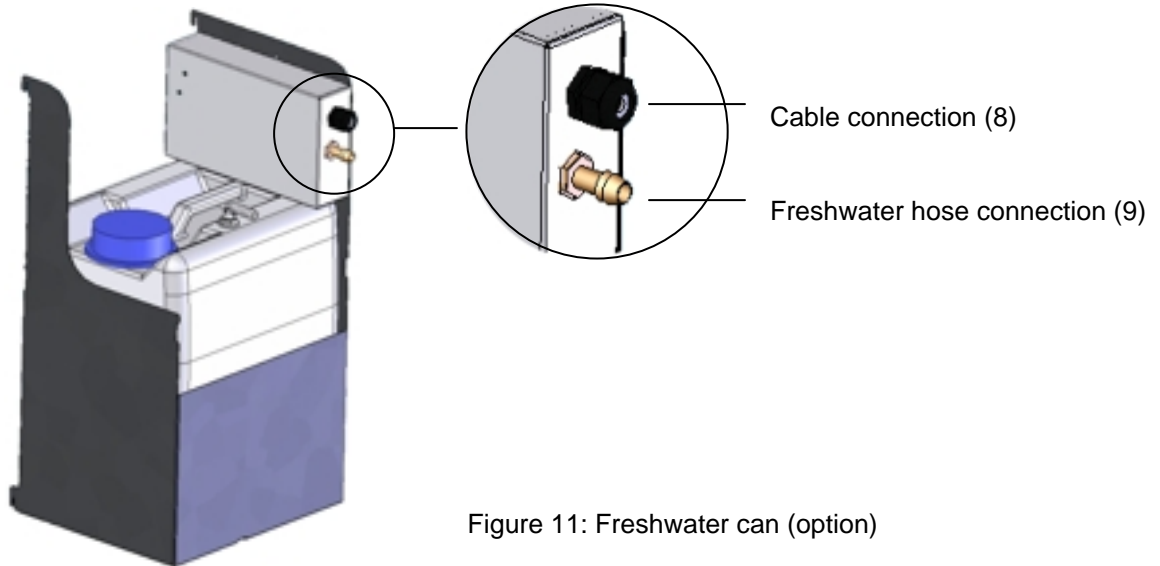

Figure 11: Freshwater can (option)

(2) Cable connections

Connect the plug of the cable to the socket (3) at the rear of the cabinet.

The socket (3) is marked with a sticker:

WATER TANK
24 VDC/MAX 0.2A

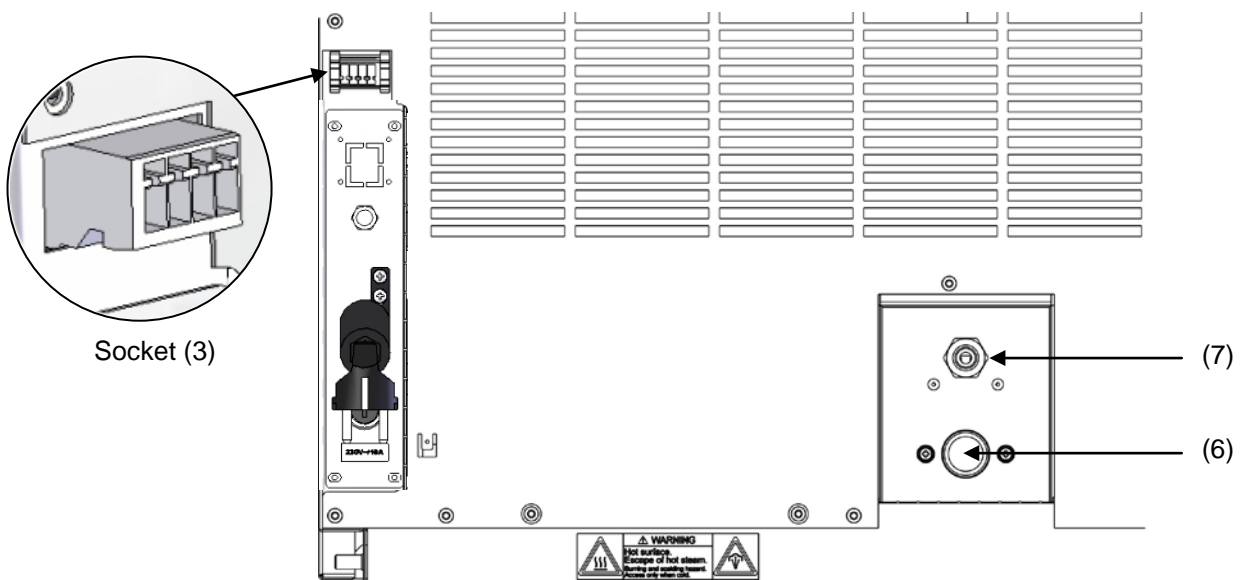



Figure 12: Connections at the cabinet rear

(3) Hose connections

Plug the freshwater hose into the hose connection (9) above the freshwater can and secure it with a hose clamp. You can use a part of the standard supplied water hose.

Screw the hose nozzle (brass) to the free edge of the hose and screw it directly onto the freshwater connection "IN" (6) at the rear of the cabinet.

When the freshwater can is empty, the message "Freshwater supply" will be displayed on the controller (chap. 11.1.3), the buzzer sounds, and the humidification module turns off. After acknowledging the alarm, the humidification module tries to fill up and start operating.

	To guarantee humidification during 24 hours even at high humidity set-points with manual water supply, we recommend filling the freshwater can (option) at the end of each day.
---	---

4.5.2 Mounting the wastewater can

(1) Fixing (if required)

Hang the can with its holding device on its 4 carriers at the free space next to the freshwater can.

(2) Hose connections

Plug the wastewater hose to the hose connection (10) of the wastewater can and secure it with a hose clamp. You can use a part of the standard supplied water hose.

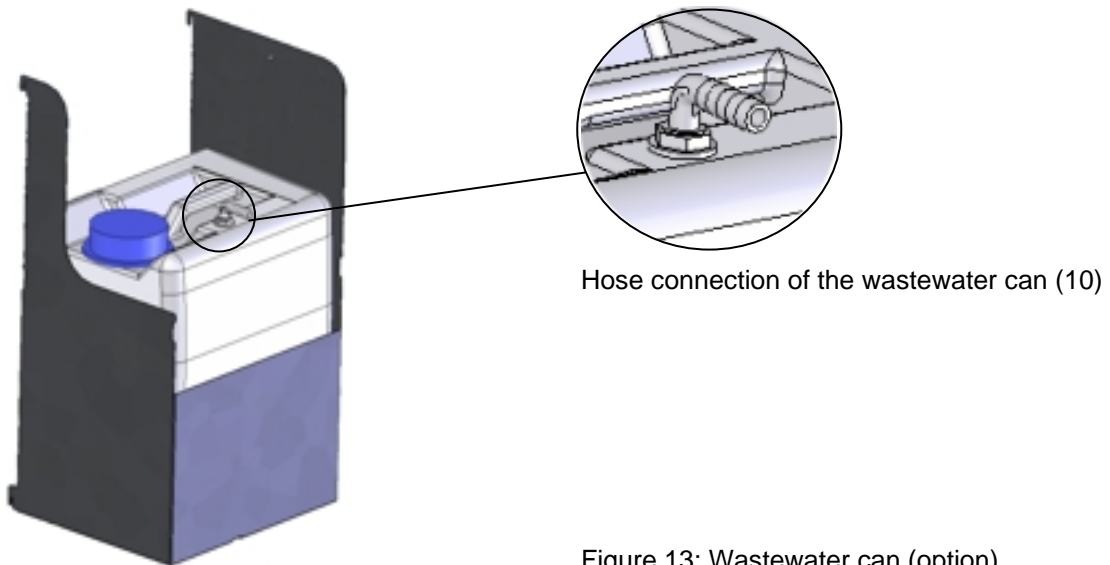



Figure 13: Wastewater can (option)

Plug the free hose edge to the wastewater connection "OUT" (7) at the rear of the cabinet and secure it with a hose clamp.

You can remove the wastewater can with its holding device for emptying (disconnect the hose first before emptying).

	CAUTION
	<p>Overflow of the wastewater can.</p> <p>Damage to the surrounding.</p> <p>➤ Empty the wastewater can in a timely manner before it is full.</p>

	Bringing a source of humidity into the inner chamber may increase wastewater production. Regularly check the filling level of the wastewater can.
---	---

4.5.3 Mounting with wastewater recycling

When the cabinet interior is clean, you can reuse the wastewater from the cabinet. Connect the wastewater connection “OUT” (7) of the cabinet with the freshwater hose connection (11) of the freshwater can. The wastewater can is not used in this case.

	CAUTION
	<p>Soiling of the vapor humidification system.</p> <p>Damage to the cabinet.</p> <ul style="list-style-type: none"> ➤ Reuse wastewater ONLY with a clean cabinet interior. ➤ In case of soiling / contamination of the interior, conduct the wastewater to the wastewater connection or use the wastewater can.

(1) Fixing of the freshwater can (if required)

Hang the can with its holding device on its 4 carriers. You can install it either at the left or the right side.

(2) Cable connections of the freshwater can

Connect the plug of the cable to the socket (3) at the rear of the cabinet as described in chap. 2.4.

(3) Hose connections

Plug the wastewater hose into the hose connection (11) of the freshwater can and secure it with a hose clamp. You can use a part of the standard supplied water hose.

Plug the free hose edge to the wastewater connection “OUT” (7) at the rear of the cabinet and secure it with a hose clamp.

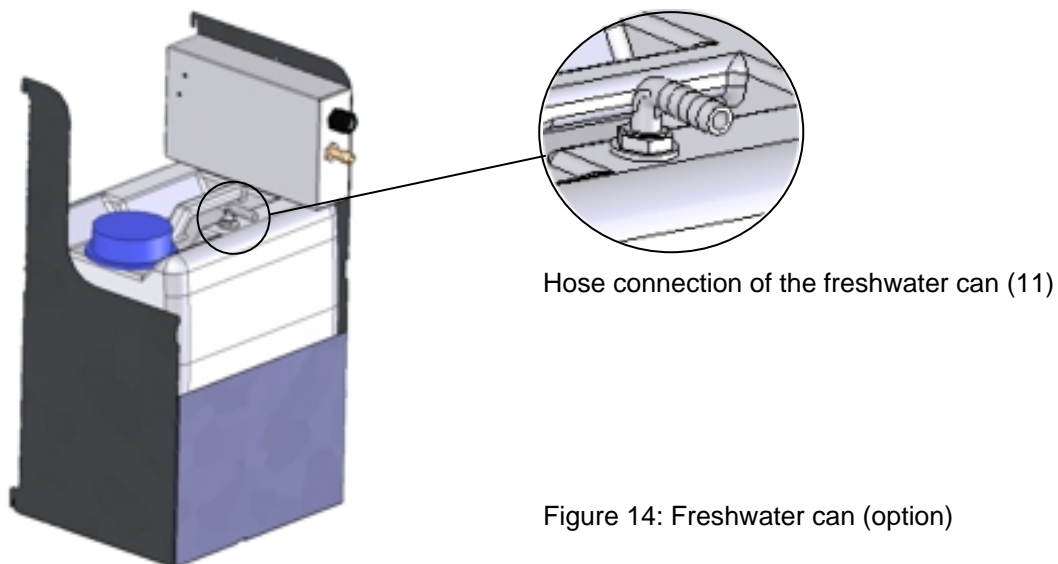

	<p>Bringing a source of humidity into the inner chamber may increase wastewater production. Regularly check the filling level of the freshwater can.</p>
---	--



4.6 Placement of the light cassettes (cabinet with lights)

The light cassettes are permanently connected. The cable length permits easily removal to replace the fluorescent tubes or to change the position of the light cassette inside the cabinet.

You can insert the light cassettes in different heights onto the beads at the lateral walls of the chamber. Insert and pull out the light cassettes only by the handles.

Do not place any charging material directly onto the light cassettes because those are heated by the fluorescent tubes which would lead to exposing the charging material to undefined temperatures. The temperature directly below or on the light cassettes is not equal to the temperature displayed at the temperature controller.

	Place the charging material on the supplied racks below the light cassettes.
---	--

	 CAUTION
	<p>The light cassettes will become hot with temperature set-points >40 °C.</p> <p>Danger of burning.</p> <ul style="list-style-type: none"> ⊘ Do NOT touch the light cassettes during operation. ➤ Let the light cassettes cool down before changing their position.

4.7 Electrical connection

The cabinets are supplied ready for connection. They come with a fixed power connection cable of at least 1800 mm / 70.87 in in length.



- Power plug: NEMA 6-20P
- Voltage +/-10% at the indicated power frequency: 200-240 V at 50Hz, 200-240 V at 60Hz
- Current type: 2~
- Cabinet fuse: 16 Amp
- The domestic socket must also provide a protective conductor. Make sure that the connection of the protective conductor of the domestic installations to the cabinet's protective conductor meets the latest technology. The protective conductors of the socket and plug must be compatible!
- Prior to connection and start-up, check the power supply voltage. Compare the values to the specified data located on the cabinet's type plate (left cabinet side, bottom right-hand, see chap. 1.4).
- When connecting, please observe the regulations specified by the local electricity supply company. We recommend the use of a residual current circuit breaker.
- Pollution degree (acc. to IEC 61010-1): 2
- Installation category (acc. to IEC 61010-1): II

	CAUTION
	<p>Danger of incorrect power supply voltage.</p> <p>Damage to the equipment.</p> <ul style="list-style-type: none"> ➤ Check the power supply voltage before connection and start-up. ➤ Compare the power supply voltage with the data indicated on the type plate.

See also electrical data (chap. 23.4).

	To completely separate the cabinet from the power supply, you must disconnect the power plug. Install the cabinet in a way that the power plug is easily accessible and can be easily pulled in case of danger.
---	---

Remark when operating the cabinet with a power frequency of 60 Hz:



	 WARNING
	<p>High leakage current. Electrical hazard.</p> <ul style="list-style-type: none"> ➤ Earth connection is essential before connecting supply. Check socket before inserting plug.

When connected to a power supply 1N~ with a frequency of 60 Hz, a leakage current of more than 3.5 mAmp is possible. If grounding through the power cable is insufficient or missing, the leakage current may flow through the user's body. Correct installation of the professional grade power socket provided by the user safely avoids this. Before connecting the chamber to the socket, please check its grounding contact type plug for appropriate construction and if it is undamaged.

4.8 Connection of the optional voltage changer

The voltage changer enables the cabinet to operate at a power frequency of 115 Volt. It is packed separately and supplied together with the cabinet.

The voltage changer is supplied with a fixed power connection cable with a NEMA 5-20P plug. It is protected against excess-current with an internal over-current release category B16A. The connection is made by the customer.

	 CAUTION
	<p>Sliding or tilting of the voltage changer. Damage to the voltage changer. Risk of injury by lifting heavy loads.</p> <ul style="list-style-type: none"> ➤ Lift the voltage changer at both carrying handles from the pallet with two persons.

Do not install the voltage changer in the exhaust air flow at the rear of the cabinet.

For the installation of the voltage changer next to the cabinet, provide a wall distance the cabinet of approx. 0.4 m / 1.3 ft.

	CAUTION
	<p>Danger of overheating. Damage to the voltage changer.</p> <ul style="list-style-type: none"> ⊘ Do NOT install the voltage changer in unventilated recesses. ➤ Ensure sufficient ventilation for dispersal of the heat.

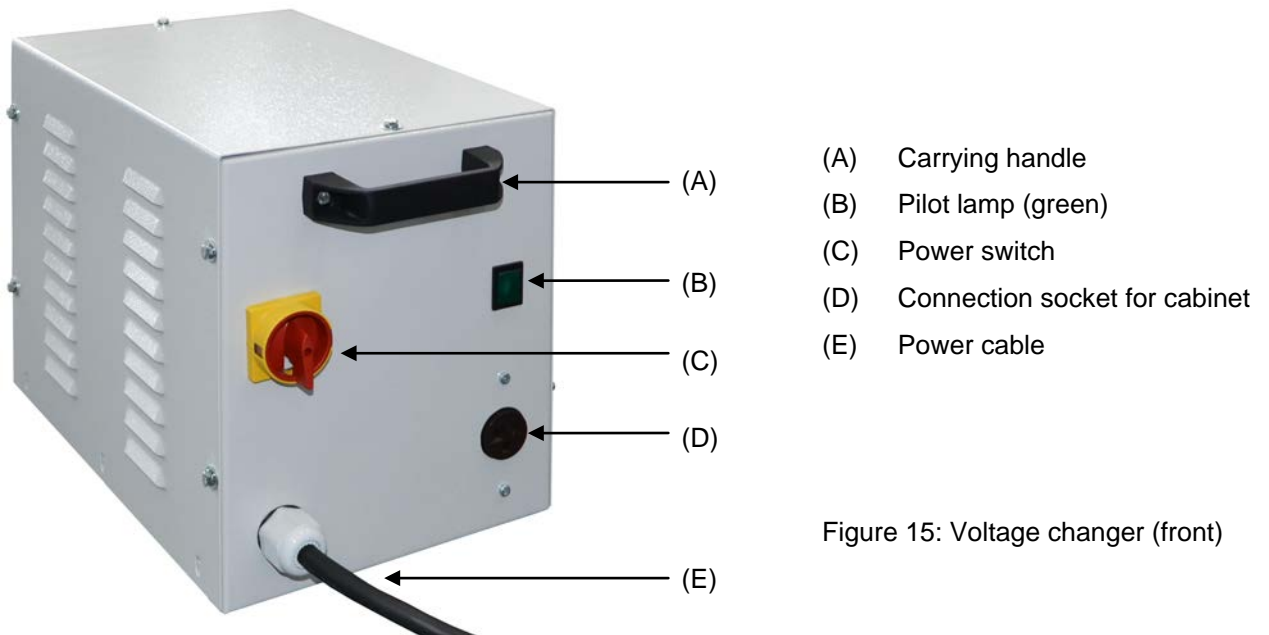

Figure 15: Voltage changer (front)

To establish the electrical connection of the cabinet with the voltage changer, proceed in the following order:

1. Connect the power cable of the cabinet to the connection socket (D) of the voltage changer
2. Establish the power connection of the voltage changer. The socket must provide a protective conductor.
3. Turn on the voltage changer at the power switch (C) (position "I"). The green pilot lamp (B) lights up.
4. Turn on the cabinet with the main power switch (1) in the lateral control panel



Position "0" = off

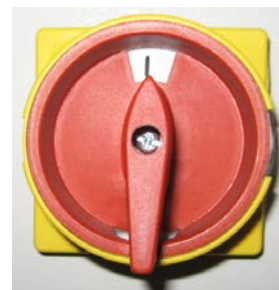

Position "I" = on

Figure 16: Power switch of the voltage changer

Dimensions of the voltage changer		
Width	mm	255
Depth (without door handles)	mm	360
Depth (incl. cable and door handles)	mm	450
Height	mm	300
Length of the connection cable to wall socket	mm	172
Lateral wall clearance of the cabinet to set up the voltage changer (minimum)	mm	400
Electrical connection data of the voltage changer		
Input side	V	115
	A	26,9
Output side (to the cabinet)	V	214
	A	13,0
Power frequency	Hz	50 / 60

5. Functional overview of the MB2 chamber controller

The MB2 chamber controller controls following parameters inside the cabinet:

- Temperature in °C
- Relative humidity in % r.H.
- Light intensity (cabinet with lights) in %
- Fan speed in %

For the control ranges of temperature and humidity, see climatic diagrams (chap. 17).

You can enter the desired set point values in fixed value operation mode directly on the display surface or via the setpoint menu. For program operation the controller offers programming week and time programs. In addition there is a timer program available (stopwatch function).

The controller offers various notifications and alarm messages with visual and audible indication and remote alarms via e-mail, an event list (trace file) and the graphical display of the measuring values in the in der chart recorder view. The MB2 program controller permits programming temperature and humidity cycles and also defining the light intensity (cabinet with lights), fan speed and special controller functions for each program section. You can enter values or programs directly at the controller or use the APT-COM™ 3 DataControlSystem software (option) specially developed by BINDER.

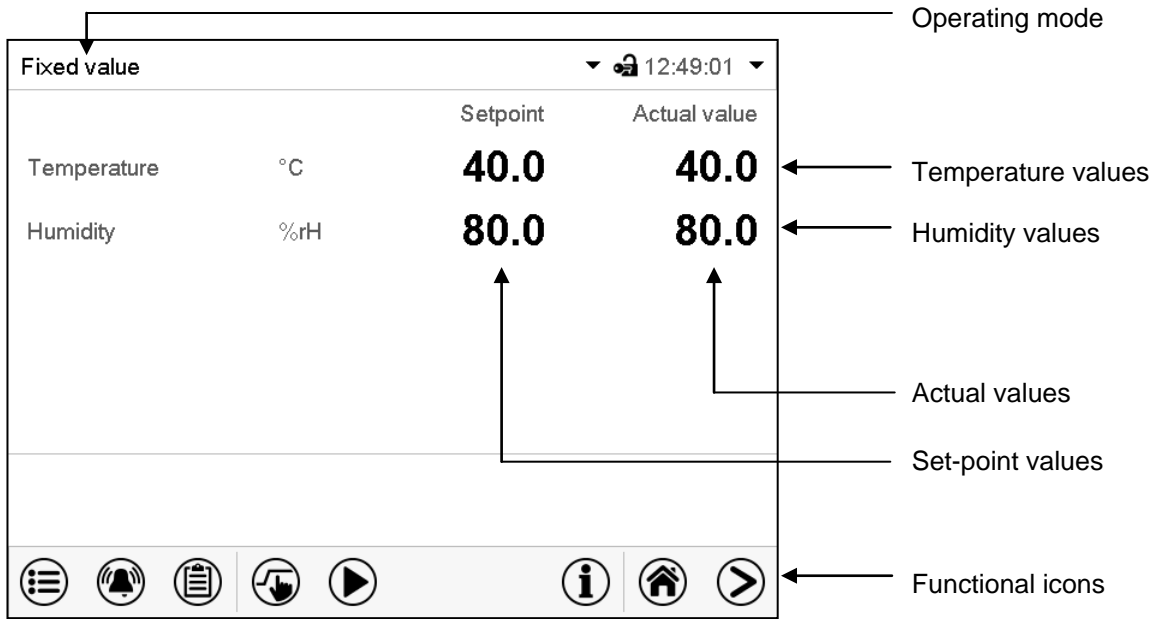

Figure 17: Normal display of the MB2 program controller (sample values), cabinet without lights

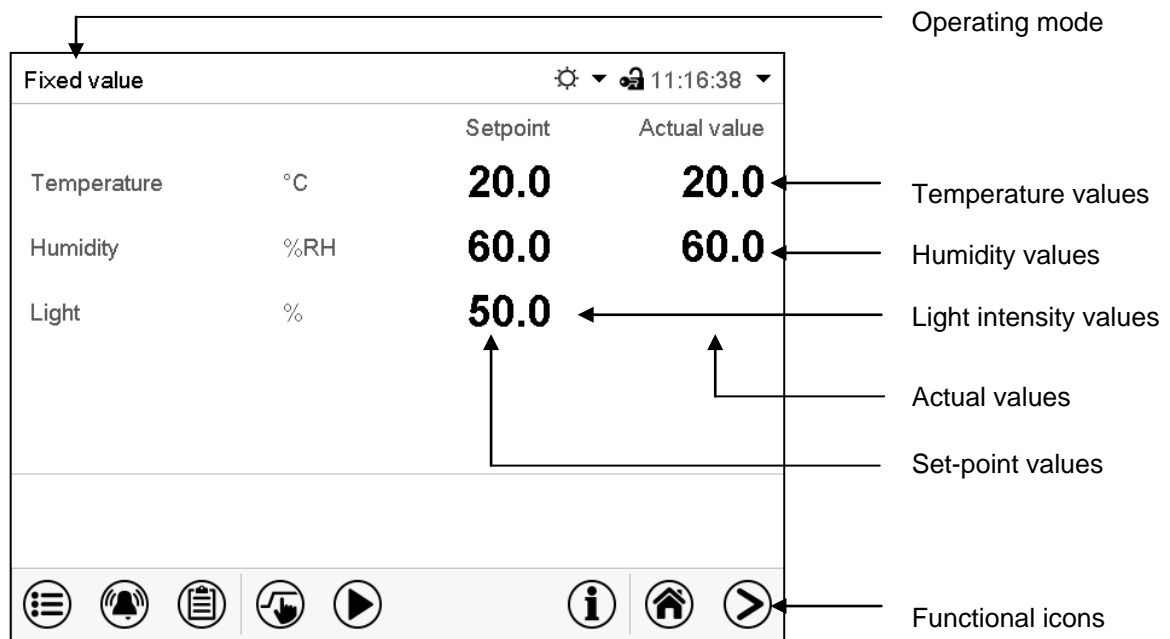

Figure 18: Normal display of the MB2 program controller (sample values), cabinet with lights

5.1 Operating functions in normal display

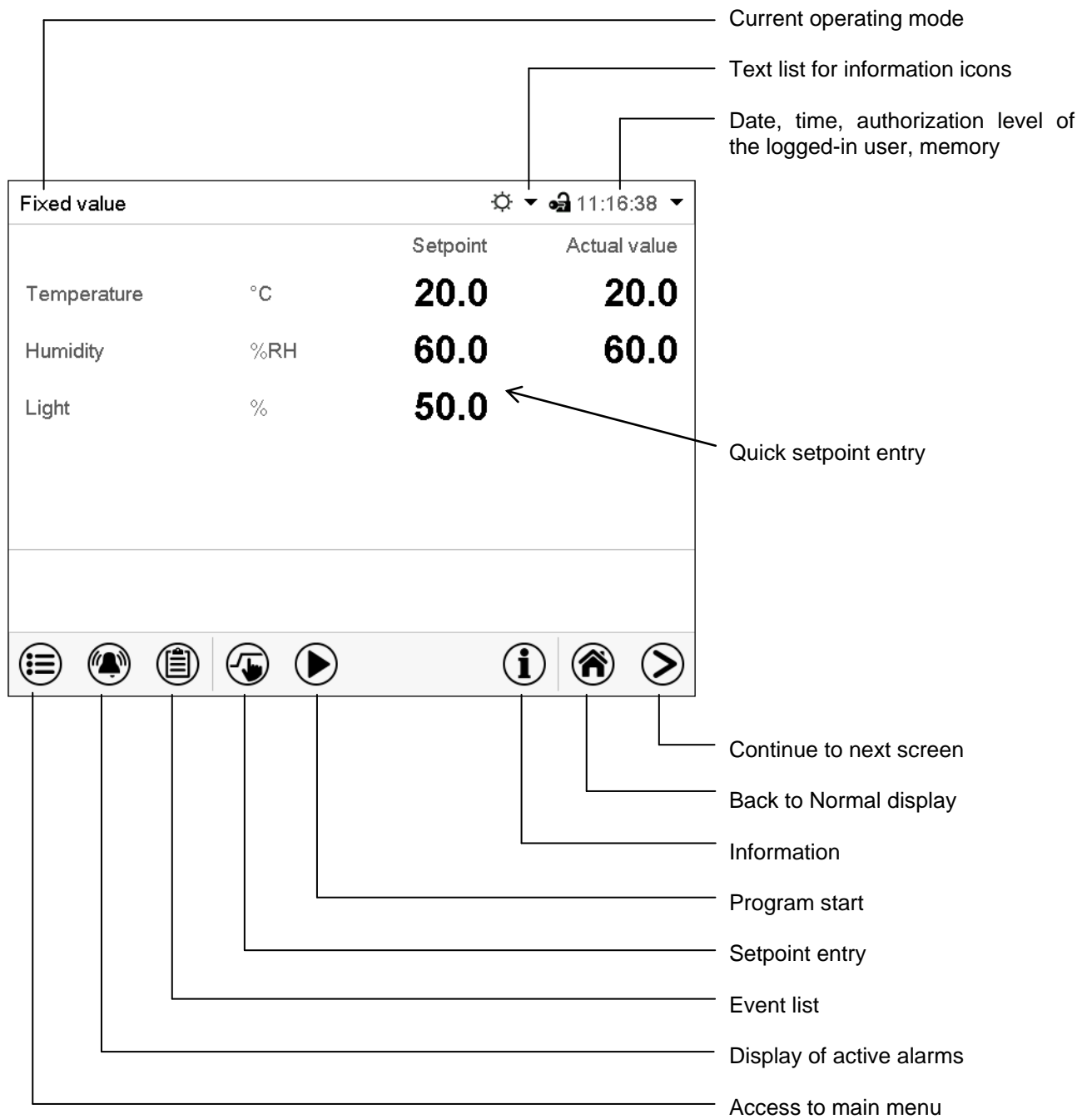

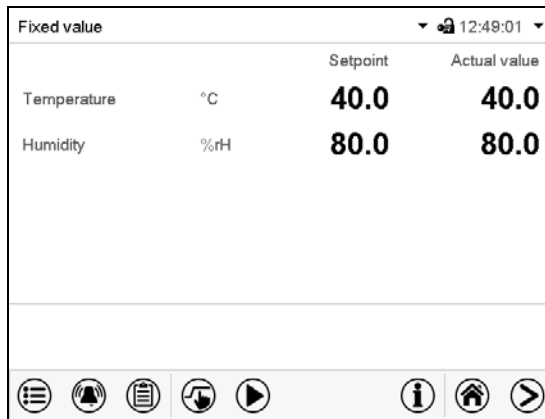

Figure 19: Operating functions of the MB2 controller in normal display (example values for cabinet with lights)

5.2 Display views: Normal display, program display, chart-recorder display

	Press the Change view icon to toggle between normal display, program display and chart-recorder display.
	Press the Normal display icon to return from program display and chart recorder display back to Normal display.

- Normal display (actual values / setpoint values)



(Cabinet without lights)

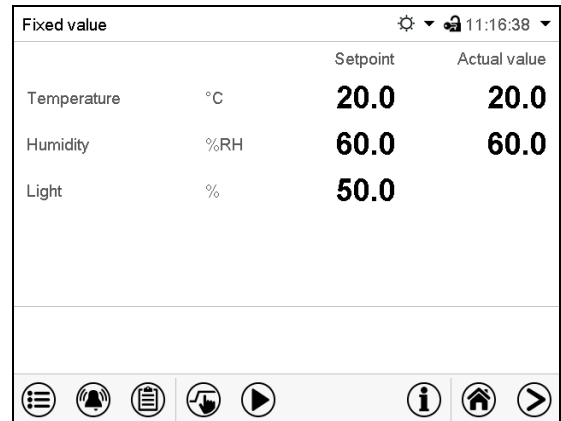

(Cabinet with lights)

- Program display (example: time program)

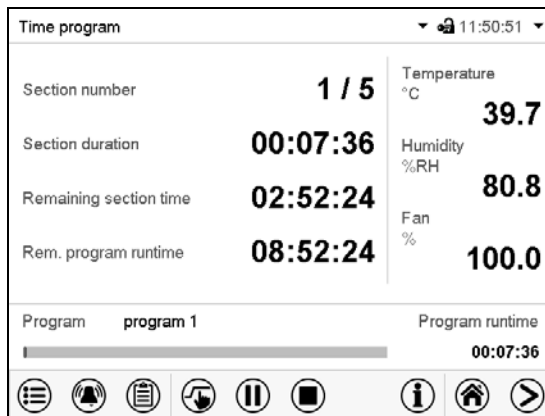

- Chart recorder display

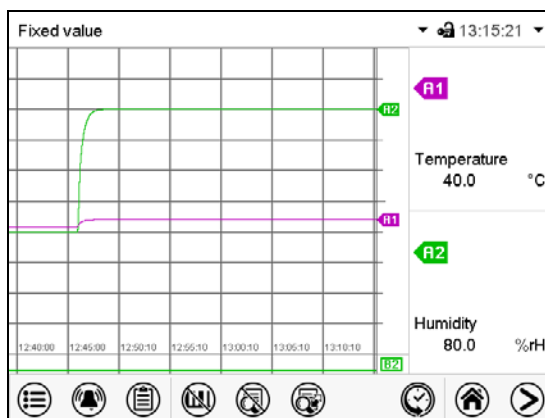



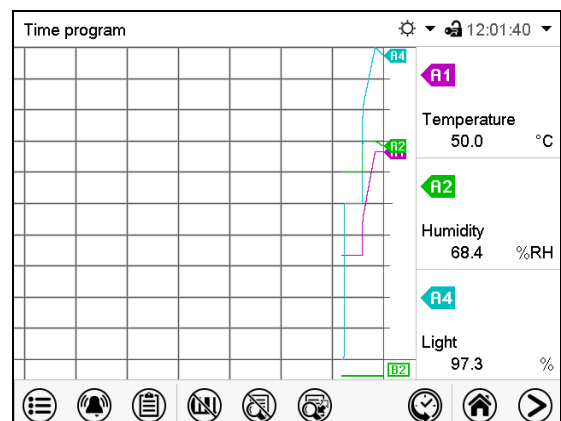







(Cabinet without lights)









(Cabinet with lights)

5.3 Controller icons overview











Navigation icons in Normal display

Icon	Signification	Function
	Main menu	Access from Normal display to the main menu
	Alarm	Access from Normal display to the list of active alarms
	Event list	Access from Normal display to the event list
	Setpoint setting	Access from Normal display to the setpoint entry menu: setpoint entry for Fixed value operation, turning on/off humidity control, safety controller settings
	Program start	Start a previously entered time or week program, continue a paused time program
	Program pause	Pause a running time program
	Program cancelling	Cancel a running time or week program
	Information	Information on program operation, setpoints, actual values, and the safety controller
	Normal display	Return from program display or chart recorder display to Normal display
	Change view	Toggle between Normal display, program display, and chart recorder display





Functional icons in individual menus

Icon	Signification	Function
	Back	Return from each menu to Normal display
	Update	Update the event list and alarm messages
	Confirm	Take over the entries and exit the menu / continue menu sequence.
	Close	Exit the menu / cancel menu sequence. Entries are not taken over. When terminating a menu sequence, an information window appears, which must be confirmed.
	Reset alarm	Acknowledge the alarm and mute the buzzer.
	Change keyboard	Change between uppercase and lower case characters, digits and special characters
	Edit	Edit settings of time and week programs

Functional icons in the chart recorder display

Icon	Signification	Function
	Show legend	Show legend
	Hide legend	Hide legend
	Switch legend	Switch between legend pages
	Show indications	Show indication "Door open" (B2)
	Hide indications	Hide indication "Door open" (B2)
	History display	Pause chart recorder and change to history display. Data recording continues.
	Curve selection	Go to "Curve selection" submenu in the history display
	Search	Go to "Search" submenu in the history display to select the required instant
	Zoom	Go to "Zoom" submenu in the history display to select the zoom factor
	Show scroll buttons	Show scroll buttons in the history display to scroll to an instant
	Hide scroll buttons	Hide scroll buttons in the history display to scroll to an instant

Information icons referring to chamber conditions

Icon	Text information	Condition
	"Idle mode"	Controller in Idle mode
	"Temperature range"	Current actual temperature value outside the tolerance range
	"Humidity range"	Current actual humidity value outside the tolerance range
	"Door open"	Cabinet door is open
	"Humidity off"	The humidification / dehumidification system is turned off

Information icon in the touchscreen calibration menu

Symbol	Information
	Remaining time to touch the display when calibrating the touchscreen.

5.4 Operating modes

The MB2 program controller operates in the following operating modes:

- **Idle mode**

The controller is not functional, i.e., there is no heating or refrigeration and no humidification or dehumidification. The fan is off. Cabinet with lights: The fluorescent tubes are off. The cabinet approximates ambient values.

You can activate and deactivate this operating mode with the “Idle mode” control contact in Fixed value operating mode (chap. 7.3), time program operation (chap. 9.7.3) and week program operation (chap. 10.6.5).

- **Fixed value operating mode**

The controller operates as a fixed-point controller, i.e., set-points for temperature and humidity, fan speed and light intensity (cabinet with lights) can be defined, which are then maintained until the next manual change (chap. 7.1).

- **Timer program operation**

Stopwatch function: during an entered duration the controller constantly equilibrates to the setpoints entered in Fixed value operation mode.

- **Time program operation**

An entered time program for temperature, humidity fan speed and light intensity (cabinet with lights is running. The controller offers 25 program memory places with 100 program sections each. The total number of program sections of all programs is unlimited

- **Week program operation**

An entered week program for temperature, humidity fan speed and light intensity (cabinet with lights is running. The controller offers 5 program memory places with 100 switching points each. The switching points can be distributed over all days of the week.

5.5 Controller menu structure

Use the **navigation icons** in the screen footer in Normal display to access the desired controller functions.

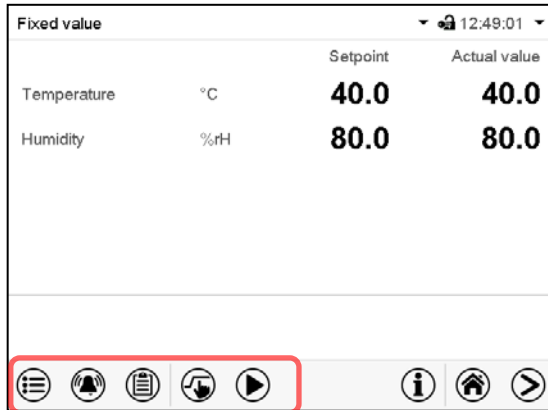

Normal display (cabinet without lights)

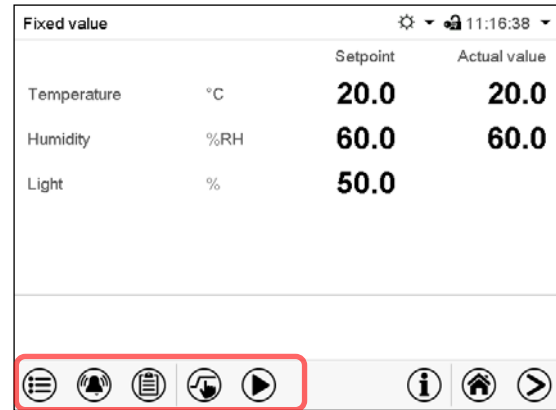

Normal display (cabinet with lights)



The available functions depend on the current **authorization level** “Service”, “Admin” or “User” (chap. 13.1). This is selected either during login or can be available without password protection.

	Main menu: program settings, further information, “Service” submenu. The “Settings” submenu allows general configuration of the controller.	chap. 5.5.1
	List of active alarms	chap. 11
	Access to the event list	chap. 15.2
	Setpoint entry for Fixed value operation, turning on/off humidity control , safety controller settings	chap. 7, 6.3, 12.2
	Start/ pause/ cancel an already entered, respectively a running time program or start / cancel an already entered, respectively a running week program	chap. 9.1, 9.2, 10.1



Unless noted otherwise, the figures show the functional range, which is available for the user with “Admin” authorization level.

5.5.1 Main menu

The main menu provides access to the general configuration of the controller as well as to program entry and the user administration. Additionally there are support functions like a contact page or the display calibration depending on the available angle.

	Press the Main menu icon to access the main menu from Normal Display.
	Press the Back icon to return from each setting menu to Normal Display.

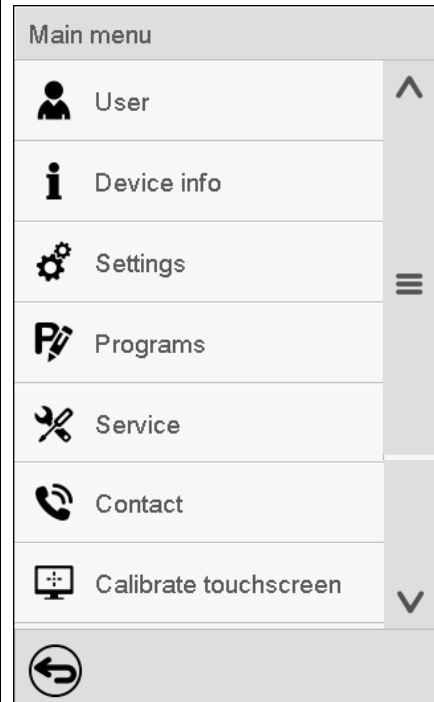
The main menu provides the following functions and submenus.

			
	User	User management: login and logout, password management	chap. 13
	Device info	Cabinet information	chap. 15.2
	Settings	“Settings” submenu (not visible for user with “User” authorization level)	chap. 14
	Programs	Program entry submenu for time and week programs	chap. 9 and 10
	Service	“Service” submenu	chap. 5.5.3
	Contact	Datacolor service contact page	chap. 15.1
	Calibrate touchscreen	Calibrating the touch screen	chap. 14.4.2
	Back to Normal Display		

“Settings” submenu

- Settings of many general controller functions and network settings (chap. 14).
- Available only for users with “Service” and “Admin” authorization level

“Service” submenu

- Access to service data, controller reset to factory settings (chap. 5.5.3)
- Available only for users with “Service” and “Admin” authorization level. Full functional range only for Datacolor service representatives (users with “Service” authorization level).

“Programs” submenu

- Access to the controller’s program functions (chap. 8, 9, 10)

5.5.2 “Settings” submenu

The “Settings” submenu is available for users with “Service” or “Admin” authorization level. It serves to enter date and time, select the language for the controller menus and the desired temperature unit and to configure the controller’s communication functions.

Path: [Main menu > Settings](#)

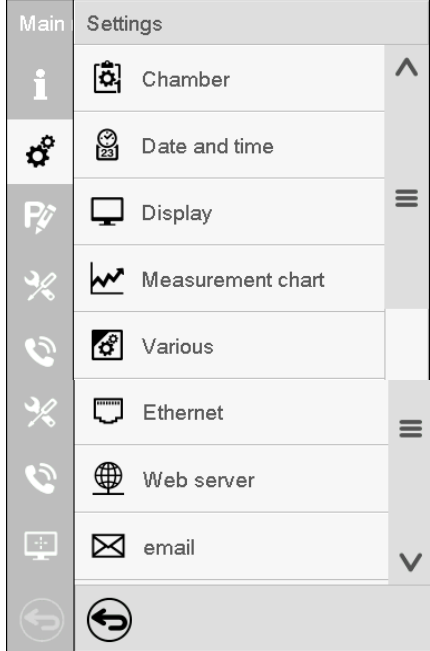
	Settings		
	Chamber	Setting the temperature unit, menu language...	chap. 14.1, 14.2
	Date and time	Setting date and time	chap. 14.3
	Display	Setting the display brightness, continuous operation and screen saver	chap. 14.4
	Measurement chart	Settings for the measurement chart: storage interval, storage values, min. and max. values	chap. 16.2
	Various	Setting the tolerance range and delay time for tolerance range alarm	chap. 11.4
	Ethernet	Entry of the MAC address and IP address	chap. 14.5.1
	Web server	Password protection for web server access	chap. 14.5.2
	email	Configuration of the e-mail server, assignment of e-mail addresses	chap. 14.5.3
		Back to main menu	

5.5.3 “Service” submenu

The “Service” submenu is available for users with “Service” or “Admin” authorization level. When logged-in with “Admin” authorization level the user will find information to tell your local Datacolor service representative in service case.

Path: [Main menu > Service](#)

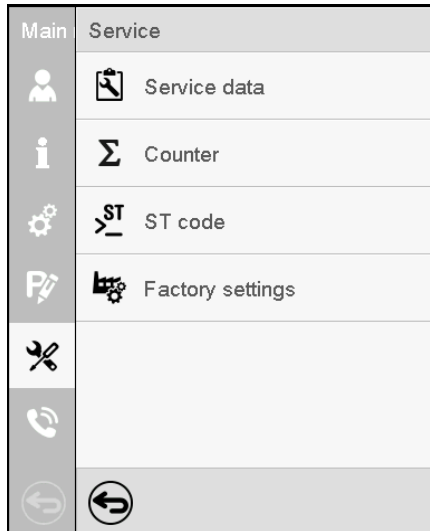
	Service		
	Service data	Serial number of the cabinet, setup version of the controller software	chap. 14.2
	Counter	Counter of operating hours	chap. 15.4
	ST code	Information for your Datacolor service representative	
	Factory settings	Reset to factory settings	
		Back to main menu	

(view with “Admin” authorization level)

5.6 Principle of controller entries

In the selection and entry menus there are icons displayed in the footers which you can use to take over the entry or cancel it.

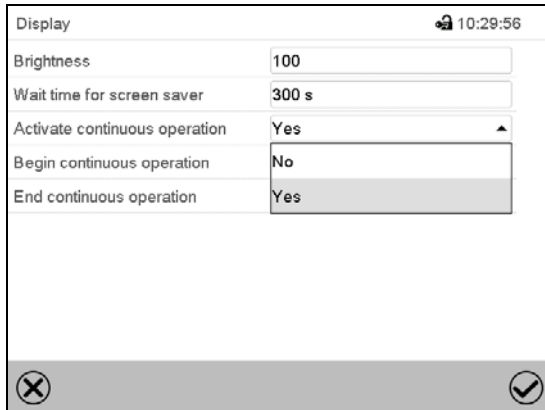

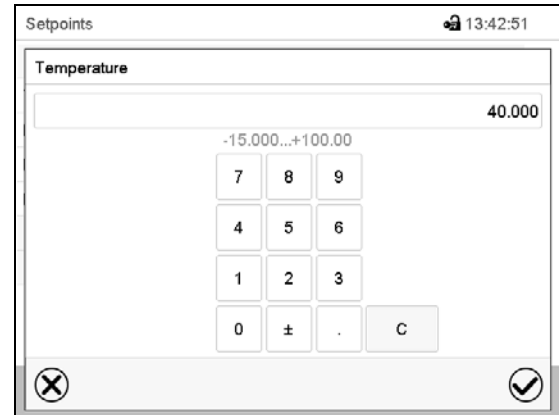

Selection menu (example)



Entry menu (example)

After completing the settings there are the following possibilities:

	Press the Confirm icon to take over the entries and exit the menu or continue the menu sequence.
	Press the Close icon to exit the menu or cancel the menu sequence without taking over the entries. When terminating a menu sequence, an information window appears, which must be confirmed.

5.7 Performance during and after power failures

During a power failure, all controller functions are shut down.

After the power returns, all functions return to the same status the cabinet had before power failure. The controller continues to function in the original operating mode it was in previously before the power failure occurred.

- Performance after power failure in Idle mode
Control is deactivated
- Performance after power failure in Fixed value operation mode
All functions return to the same status the cabinet had before power failure. The set-points are immediately resumed.
- Performance after power failure during time program operation
The program is resumed at the point where the interruption occurred with the latest set-points reached during the program run.
- Performance after power failure during week program operation
The week program continues with the values corresponding to the current time.

Power failure and power return are noted in the event list (chap. 15.3).

If during power failure an alarm has occurred (tolerance range, safety controller), confirm the alarm. See chap. 11.3.

5.8 Performance when opening the door

When you open the door the fan starts running with minimum speed.

After 60 seconds from opening the door, heating, refrigeration, humidification, dehumidification and fan turn off.

After closing the door, heating, refrigeration, humidification, dehumidification and fan turn on again.

6. Start up

6.1 Turning on the cabinet

After connecting the supply lines (chap. 4), turn on the cabinet by its main power switch (1). The lit pilot lamp shows the cabinet is ready for operation.

When the main power switch is turned on and yet the controller display is dark, the display is in stand-by mode. Press on the touchscreen to activate it.

- Open the water-tap for freshwater supply. Alternatively, fill the freshwater can (option, chap. 4.5).
- The humidifying and dehumidifying system must be activated (deactivated operation line "Humidity off", chap. 7.3 and setting "Control on", chap. 6.3).

After the first turning on of the cabinet or after an interruption of the power supply the relative humidity will increase after a delay of about 20 minutes, as the fresh water needs to be heated first. During this period, the relative humidity can drop considerably.

The cabinet may release odors in the first few days after commissioning. This is not a quality defect. To reduce odors quickly we recommend heating up the cabinet to its nominal temperature for one day and in a well-ventilated location.



WARNING: If customer should use a cabinet running in non-supervised continuous operation, we strongly recommend in case of inclusion of irrecoverable specimen or samples to split such specimen or samples and store them in at least two cabinets, if this is feasible.

6.2 Controller settings upon start up

The window „Language selection“ enables the **language selection**, in case that it's activated in the "Start-up" menu. Afterwards occurs a request of the **time zone** and the **temperature unit**.

Language selection	
German	<input checked="" type="checkbox"/>
English	<input type="checkbox"/>

Start-up	
Temperature unit	Degrees Celsius
Time zone	UTC+1h (CET)
Daylight saving time switch	Automatic
Start of daylight saving time	
End of daylight saving time	
Language query after restart	Yes

The controller will function in the **operating mode**, which was active before the last shut-down. It controls temperature and humidity in fixed value operating mode to the last entered values and in the program mode to the set points achieved beforehand.

Locked operation

Provided that the user administration has been activated by the assignment of passwords for the different authorization types, the **controller operation** is first locked after turning on the unit, recognizable by the closed lock icon in the header.

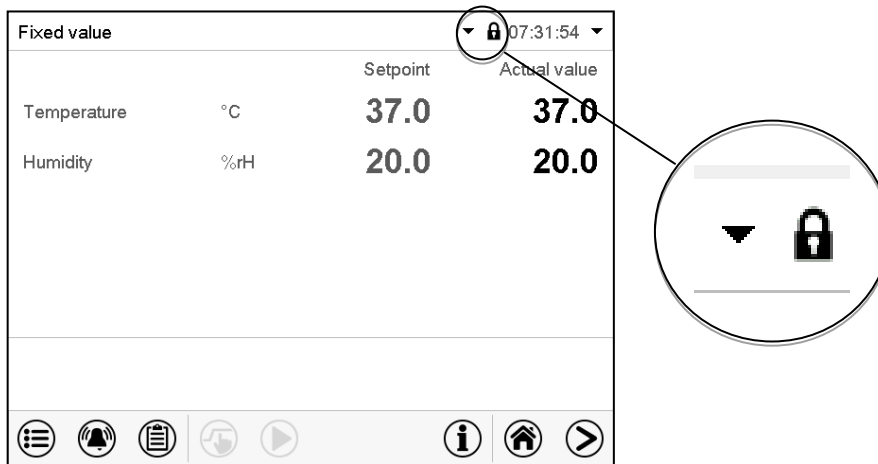

In the locked view the controller provides all display functions. No setting functions are available.

The setpoints are shaded (light grey) in normal display. Changing them by direct entry in the fixed value operating mode is not possible. The functional icons for setpoint entry and program start in the footer are without function.

After turning on the unit, user log-in is required to operate the controller (chap. 13.2)

Operation without user log-in / without password-protection

If the password function has been deactivated, after turning on the unit without user log-in there are those controller functions available, which correspond to the highest authorization level without a password protection. There is no lock icon in the header.

6.3 Turning on/off humidity control

Turning off humidity control is required when operating the cabinet without water connection in order to avoid humidity alarms. For further information see chap. 17.

 Press the **Setpoint setting** icon to access the “Setpoint” setting menu from Normal display.

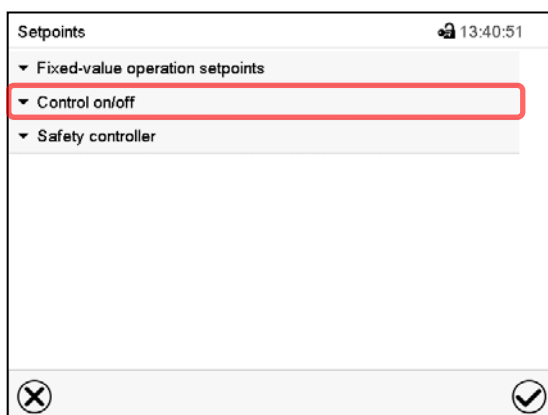

“Setpoints” menu.

Select “Control on/off”.

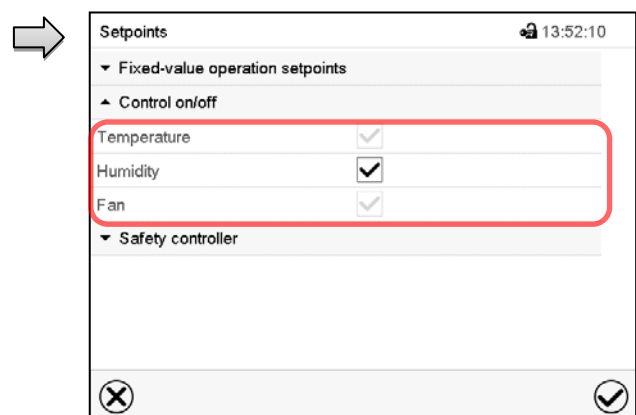

You can turn humidity control (humidification and dehumidification) on or off.

If the “Humidity “checkbox is marked, humidity control is active. Mark / unmark the checkbox to change the setting.

7. Set-point entry in “Fixed value” operating mode

In Fixed value operating mode you can enter a temperature set-point, a humidity set-point, the fan speed, and the switching-state of up to 16 operation lines.

All settings made in Fixed value operating mode remain valid until the next manual change. They are saved also when turning off the cabinet or in case of toggling to Idle Mode or Program Mode.

Cabinet without lights	Setting ranges	Control ranges
Temperature	-5 °C / 41 °F up to 70 °C / 158 °F.	0 °C / 32 °F up to 70 °C / 158 °F without humidity 10 °C / 50 °F up to 70 °C / 158 °F with humidity
Humidity	0 % r.H. up to 80 % r.H.	10 % r.H. to 80 % r.H. see climatic diagrams, chap. 17.
Fan speed	40% up to 100 %	

Cabinet with lights	Setting ranges	Control ranges
Temperature	-5 °C / 41 °F up to 50 °C / 122 °F.	0 °C / 32 °F up to 50 °C / 122 °F without humidity 10 °C / 50 °F up to 50 °C / 122 °F with humidity
Humidity	0 % r.H. up to 70 % r.H.	10 % r.H. to 70 % r.H. see climatic diagrams, chap. 17.
Light intensity	0 % to 100 %	
Fan speed	40% up to 100 %	

	<p>Reduce the fan speed only if required, because the spatial distribution of temperature and humidity will also be reduced.</p> <p>Technical data refers to 100% fan speed.</p>
---	---

For the control range of temperature and relative humidity, see the temperature / humidity diagrams chap. 17).

	<p>With set-point type “Limit”, adapt the safety controller (chap. 12.2) always when you changed the temperature set-point. Set the safety controller set-point by approx. 2 °C to 5 °C above the controller temperature set-point.</p> <p>Recommended setting: Set-point type “Offset” with safety controller set-point 2 °C.</p>
---	--

	<p>When operating without humidity by setting “Control off” (chap. 6.3), the humidity tolerance range function is automatically deactivated.</p> <p>When operating without humidity by activated operation line “Humidity off” (chap. 7.3), set the humidity tolerance range to “0” in order to avoid tolerance range alarms (chap. 11.4).</p>
---	--

7.1 Set-point entry for temperature, humidity, light intensity, and fan speed through the “Setpoints” menu

 Press the **Setpoint setting** icon to access the “Setpoint” setting menu from Normal display.

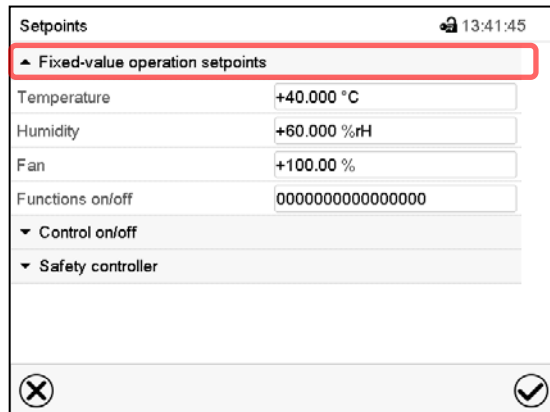

“Setpoints” menu (cabinet without lights)

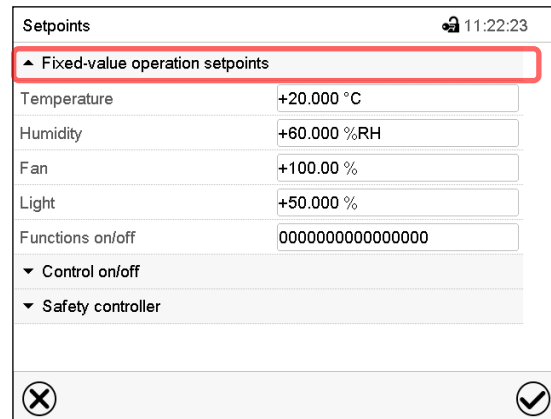

“Setpoints” menu (cabinet with lights)

Select “Fixed value operation setpoints” to access the individual parameters.

- Select the field “Temperature” and enter the desired temperature setpoint.
Cabinet without lights: Setting range: -5 °C up to 70 °C.
Cabinet with lights: Setting range: -5 °C up to 50 °C.
Confirm entry with **Confirm** icon.
- Select the field “Humidity” and enter the desired humidity setpoint.
Cabinet without lights: Setting range: 0% r.H. up to 80% r.H.
Cabinet with lights: Setting range: 0% r.H. up to 70% r.H.
Confirm entry with **Confirm** icon.
- Select the field “Fan” and enter the desired fan speed setpoint.
Setting range: 40% up to 100% fan speed.
Confirm entry with **Confirm** icon.
- Cabinet with lights: Select the field “Light” and enter the desired light intensity setpoint.
Setting range: 0% up to 100% light intensity. With setting 0% the light is off.
Confirm entry with **Confirm** icon.

 When entering a value outside the setting range, the message: “Value outside of limits! (Min: xxx, Max: xxx)” appears (xxx is a wildcard for the limits of the respective parameter). Press the **Confirm** icon and repeat the entry with a correct value.

After completing the settings, press the **Confirm** icon to take over the entries and exit the menu, **or** press the **Close** icon to exit the menu without taking over the entries.

7.2 Direct setpoint entry for temperature, humidity, and light intensity via Normal display

Alternatively you can also enter the setpoints directly via Normal display.

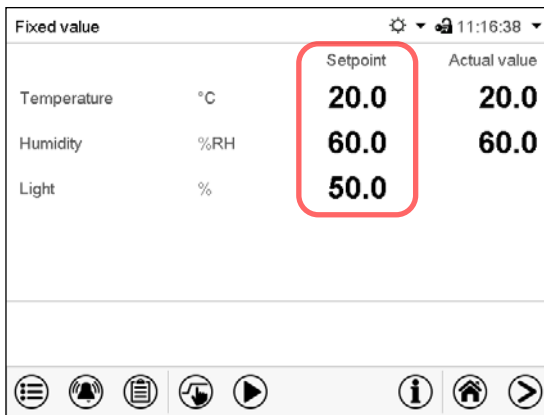

Normal display (example: cabinet with lights)
Select the setpoint you want to change.

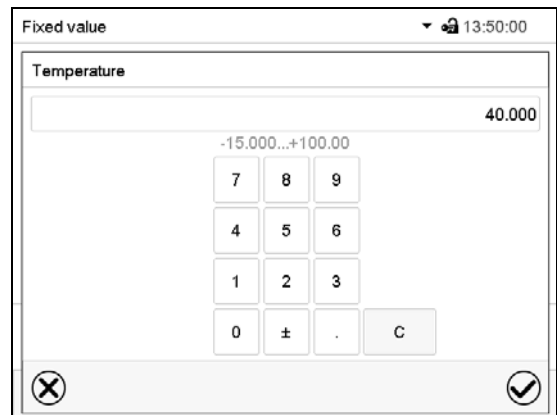

Example: "Temperature" entry menu. Enter the desired setpoint and confirm entry with **Confirm** icon.

7.3 Special controller functions via operation lines

Press the **Setpoint setting** icon to access the "Setpoint" setting menu from Normal display.

You can define the switching state of up to 16 operation lines (control contacts). They are used to activate / deactivate special controller functions.

- Operation line "Humidity off" serves to turn off the humidity.
- Operation line "Idle mode" activates / deactivates the operating mode "Idle mode".

The other operation lines are without function.

Use the "Setpoints" menu to configure the operation lines.

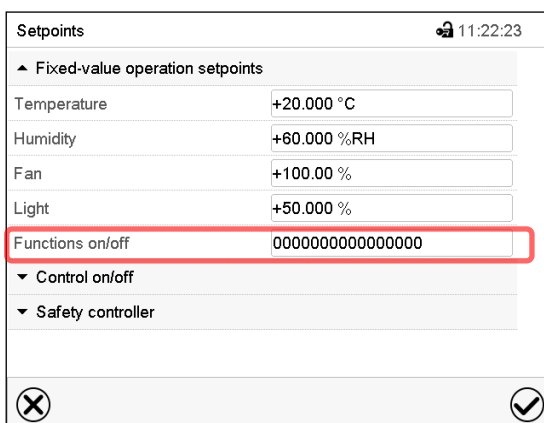

"Setpoints" menu (example: cabinet with lights)
Select the field "Functions on/off".

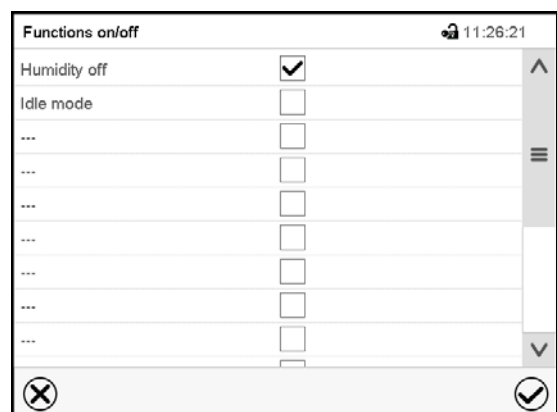

"Functions on/off" entry menu.
Mark / unmark the checkbox to activate / deactivate the desired function.

Activated operation line: switching status "1" (On), deactivated operation line: switching status "0" (Off)

The operation lines count from right to left. **Example:**

Activated operation line "Humidity off" = 0000000000000001

Deactivated operation line "Humidity off" = 0000000000000000

8. Timer program: stopwatch function

During an entered duration the controller constantly equilibrates to the setpoints entered in Fixed value operation mode (temperature, humidity, fan speed, configuration of the operation lines). This duration can be entered as a "Timer program". During the program runtime, any setpoint changes do not become effective; the controller equilibrates to the values which were active during program start.

8.1 Starting a timer program

 In Normal display press the **Program start** icon to access the "Program start" menu.

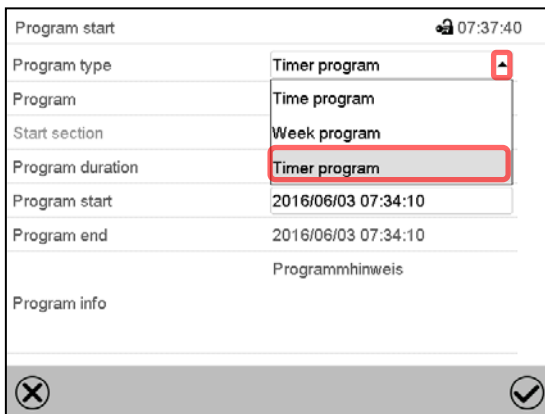

"Program start" menu.

- In the field "Program type" select "Timer program".
- Select the field "Program duration" and enter the desired program duration. Press the **Confirm** icon.
- Select the field "Program start" and enter the desired start time of the program. Press the **Confirm** icon. The program delay time until program start begins.

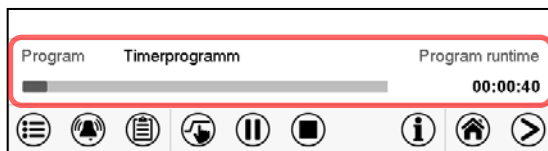

Normal display.

Information on the bottom of the screen indicates the currently running program and the time already passed. The grey bar shows how much time of the whole time is elapsed.

8.1.1 Performance during program delay time

During the configured program delay time until program start, the controller equilibrates to the current setpoints of Fixed value operation mode. Modifications of these setpoints are possible but become effective only after the timer program is finished. When the configured moment for program start is reached, the program delay time ends and the program starts running. The controller equilibrates to the values which had been active during program start

8.2 Stopping a running timer program

8.2.1 Pausing a running timer program

	Press the Program pause icon to interrupt the program.
---	---

The program is paused. The program runtime stops running down, the time display flashes.

There are the following options:

	Press the Program start icon to continue the program
---	---

	Press the Cancelling icon to cancel the program
---	--

8.2.2 Cancelling a running timer program

	Press the Program cancelling icon to cancel the program.
---	---

A confirmation prompt is displayed.

Press the **Confirm** icon to confirm that the program shall really be cancelled.

After confirming the message the controller changes to Fixed value operation mode. Temperature and humidity will then equilibrate to the setpoints of Fixed value operation mode.

8.3 Performance after the end of the program

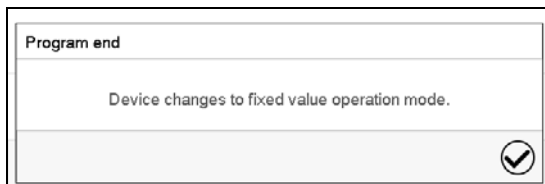

After the end of the program the message "Device changes to fixed value operation mode" appears on the screen.

Press the **Confirm** icon.

After confirming the message the controller changes to Fixed value operation mode. Temperature and humidity will then equilibrate to the setpoints of Fixed value operation mode.

9. Time programs

The MB2 program controller permits programming time programs with real-time reference. It offers 25 program memory positions with up to 100 program sections each.

For each program section you can enter a temperature set-point, fan speed, section duration, type of temperature transition (ramp or step) and the tolerance range.

	If the safety controller has been set to "limit" mode, check the setting of the safety controller when changing the temperature set-point, (chap. 12.2).
---	--

	Reduce the fan speed only if required, because the spatial distribution of temperature and humidity will also be reduced. Technical data refers to 100% fan speed.
---	--

Programming remains saved in case of a power failure or after turning off the unit.

Path: [Main menu > Programs > Time program](#)

9.1 Starting an existing time program

	In Normal display press the Program start icon to access the "Program start" menu.
---	---

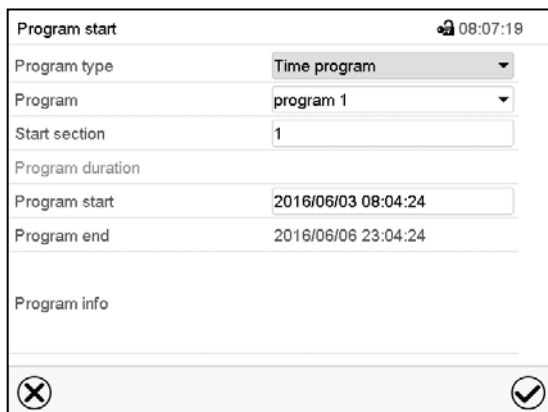

"Program start" menu

- In the field "Program type" select the setting "Time program".
- In the field "Program" select the desired program.
- Select the field "Program start" and enter the desired program start time. Press the **Confirm** icon. The program delay time until program start begins.

The program end is adapted automatically depending on the entered program duration.

After completing the settings, press the **Confirm** icon to take over the entries and exit the menu. The program starts running.

If instead you press the **Close** icon to exit the menu without taking over the entries, the program will not start.



Normal display. Information on the bottom of the screen indicates the currently running program and the time already passed. The grey bar shows how much time of the whole time is elapsed. If program duration has been set to infinite, the grey bar is not displayed.

9.1.1 Performance during program delay time

During the configured program delay time until program start, the controller equilibrates to the current setpoints of Fixed value operation mode. Modifications of these setpoints are effective. When the configured moment for program start is reached, the program delay time ends and the program starts running.



9.2 Stopping a running time program

9.2.1 Pausing a running time program

	Press the Program pause icon to interrupt the program..
---	--

The program is paused. The program runtime stops running down, the time display flashes.

There are the following options:

	Press the Program start icon to continue the program
	Press the Cancelling icon to cancel the program

9.2.2 Cancelling a running time program

	Press the Program cancelling icon to cancel the program.
---	---

A confirmation prompt is displayed. Press the **Confirm** icon to confirm that the program shall really be cancelled.

After confirming the message, the controller changes to Fixed value operation mode. Temperature and humidity will then equilibrate to the setpoints of Fixed value operation mode.

9.3 Performance after the end of the program

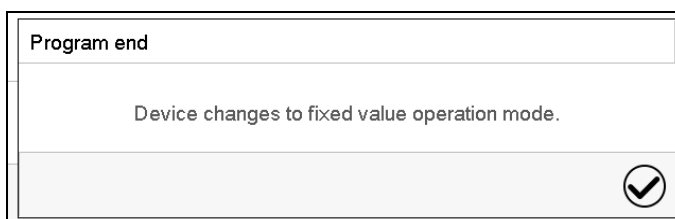

After the end of the program the message "Device changes to fixed value operation mode" appears on the screen.

Press the **Confirm** icon.

As long as the message has not been confirmed, the setpoint of the last program section remains effective. Program the last section as desired. If e.g. heating, refrigeration, humidification an dehumidification shall turn off, activate operation line "Idle mode" in the last program section.

After confirming the message the controller changes to Fixed value operation mode. Temperature and humidity will then equilibrate to the setpoints of Fixed value operation mode.

9.4 Creating a new time program

Path: *Main menu > Programs > Time program*

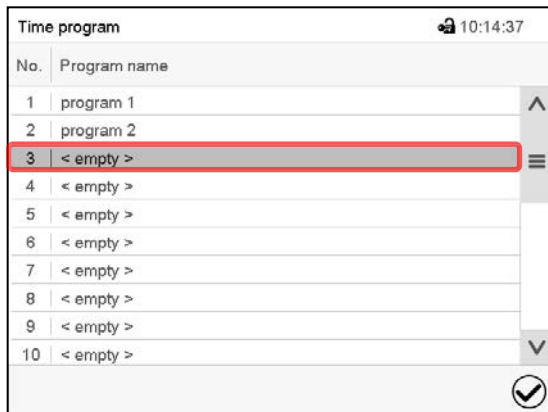

“Time program” menu:
overview of the existing programs.
Select an empty program place.

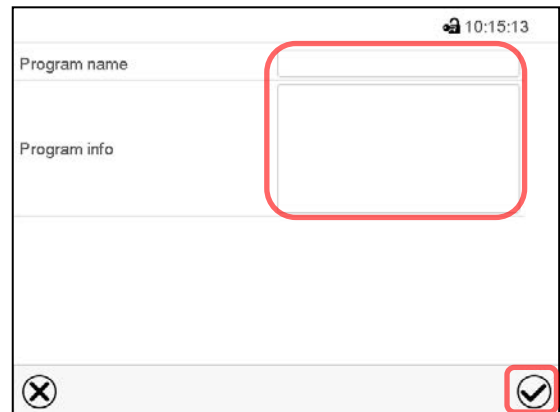

Enter the program name and, if desired, additional program information in the corresponding fields.

Press the **Confirm** icon.

The program view opens (chap. 9.5).

9.5 Program editor: program management

Path: *Main menu > Programs > Time program*

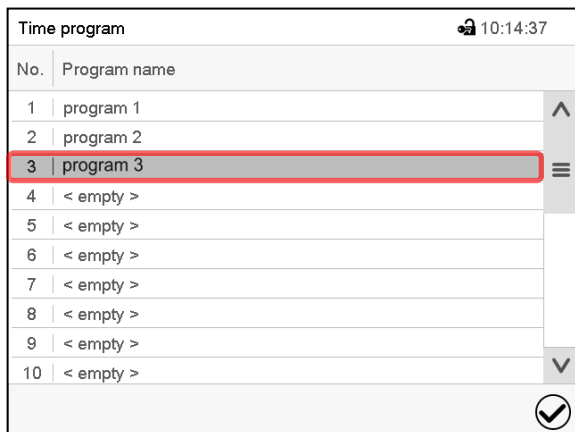

“Time program” menu:
overview of the existing programs.
Select an existing program (example: program 3) or create a new program (chap. 9.4).

The program view opens.

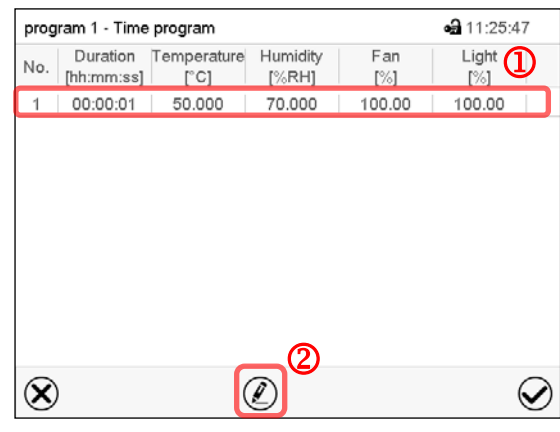

Program view (example for cabinet with lights: program 3).

If a new program has been created, there is just one program section.

There are the following options:

- ① Select a program section to open the section editor (chap. 9.6)
- ② Press the **Edit** icon to open the program editor

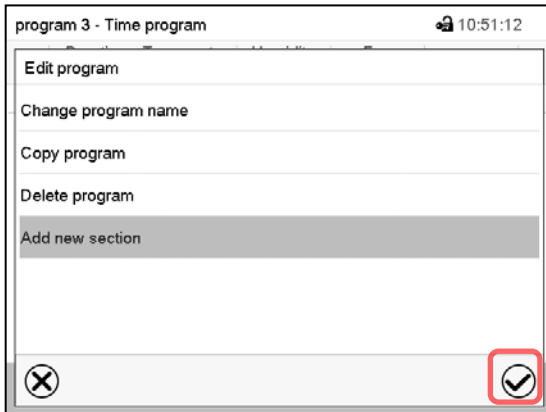

Program editor: "Edit program" menu

Select the desired function and press the **Confirm** icon.

The program editor offers following options:

- Change the program name
- Copy program
- Replace program: Replacing an new or an existing program with the copied program. This menu point is visible only after a program has been copied.
- Delete program
- Add new section

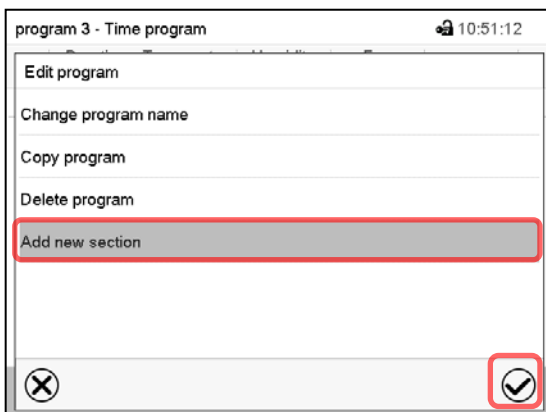

To add a new section, select "Add new section" and press the **Confirm** icon.

The program view opens.



No.	Duration [hh:mm:ss]	Temperature [°C]	Humidity [%RH]	Fan [%]	Light [%]
1	00:15:00	30.000	70.000	100.00	80.000
2	00:00:01	50.000	70.000	100.00	100.00

Program view (example: cabinet with lights).

A new section is always added at the very bottom (example: section 2).

9.5.1 Deleting a time program

Path: [Main menu](#) > [Programs](#) > [Time program](#)

In the "Time program" menu select the program to be deleted. The program view opens.

In the **program view** press the **Edit** icon to open the program editor

In the **program editor** select "Delete program" and press the **Confirm** icon.

The program is deleted. The controller returns to the program view.

9.6 Section editor: section management

Path: *Main menu > Programs > Time program*

Select the desired program.

No.	Duration [hh:mm:ss]	Temperature [°C]	Humidity [%RH]	Fan [%]	Light [%]
1	00:15:00	30.000	70.000	100.00	80.000
2	00:00:01	50.000	70.000	100.00	100.00

Program view (example: cabinet with lights).

Select the desired program section (example: section 1)



program 3 - Section number 1		10:58:07
Duration	00:00:01	①
Course	Ramp	
Functions on/off	0000000000000000	
Number of repetitions	0	②
Start section for repetition	1	
Temperature	+100.00	
Tolerance band min.	+0.0000	
Tolerance band max.	+0.0000	
Humidity	+100.00	

Section view (example: section 1).

There are the following options:

- ① Select a parameter to enter or modify the according value (chap. 9.7)
- ② Press the **Edit** icon to open the program editor



program 3 - Section number 1		11:01:06
Edit section		
Copy section		
Delete section		
Add new section		

Section editor: "Edit section" menu

Select the desired function and press the **Confirm** icon.

The section editor offers following options:

- Copy section
- Replace section: Replacing an existing section with the copied section. This menu point is visible only after a section has been copied.
- Insert section: Adding the copied section. This menu point is visible only after a section has been copied.
- Delete section
- Add new section

9.6.1 Add a new program section

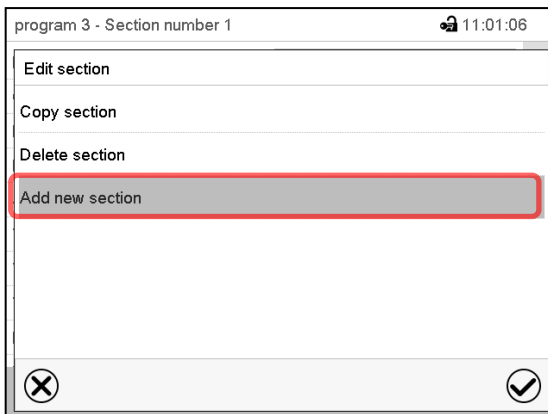

Section editor: "Edit section" menu.

Select "Add new section" and press the **Confirm** icon.

Then select whether to insert the new section before or after the current section.

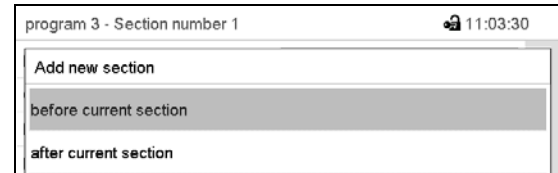

Press the **Confirm** icon. The new section opens.

9.6.2 Copy and insert or replace a program section

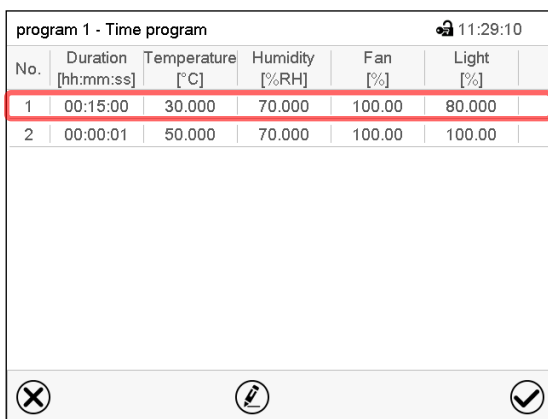

Program view (example: cabinet with lights).

Select the program section to be copied (example: section 1)

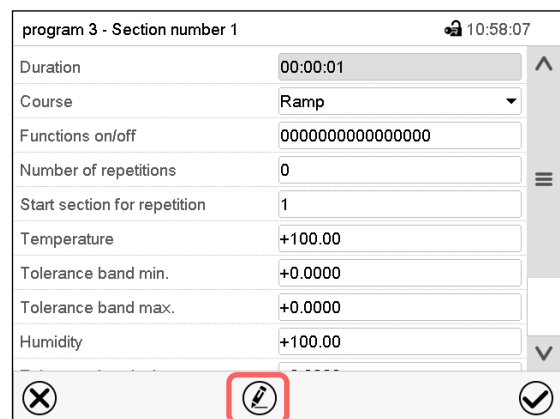

Section view (example: section 1).

Press the **Edit** icon to open the section editor.

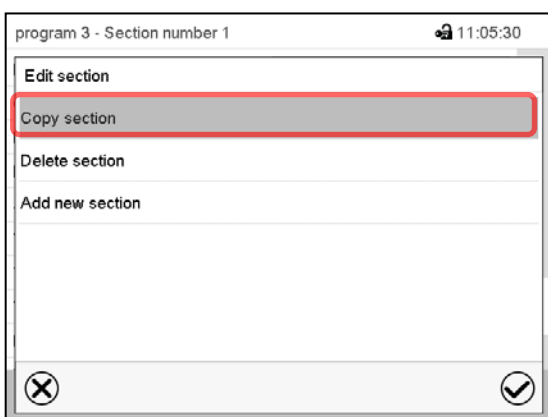

Section editor: "Edit section" menu

Select "Copy section" and press the **Confirm** icon.

The current section (example: section 1) is copied.

The controller returns to the section view.

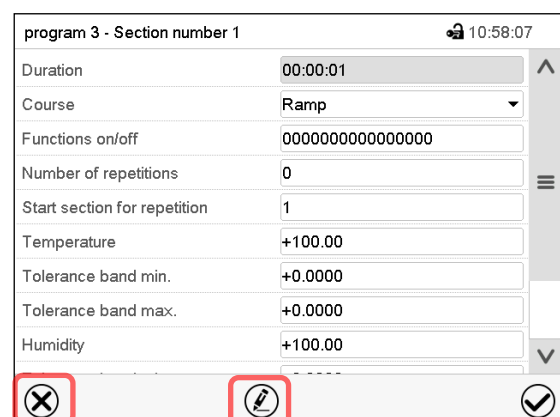

Section view (example: section 1).

Press the **Close** icon to change to the program view, if you want to select another section to be replaced or before or after which the copied section shall be inserted...

or

Press the **Edit** icon to open the section editor if you want the current section to be replaced or the copied section to be inserted before or after it

program 1 - Time program 11:29:10

No.	Duration [hh:mm:ss]	Temperature [°C]	Humidity [%RH]	Fan [%]	Light [%]
1	00:15:00	30.000	70.000	100.00	80.000
2	00:00:01	50.000	70.000	100.00	100.00

Program view (example: cabinet with lights).
Select the section to be replaced or before or after which the copied section shall be inserted (example: section 2) and press the **Confirm** icon.



program 3 - Section number 1 10:58:07

Duration: 00:00:01

Course: Ramp

Functions on/off: 0000000000000000

Number of repetitions: 0

Start section for repetition: 1

Temperature: +100.00

Tolerance band min.: +0.0000

Tolerance band max.: +0.0000

Humidity: +100.00



Section view (example: section 1).

Press the **Edit** icon to open the section editor

program 3 - Section number 2 11:09:20

Edit section

Copy section

Replace section

Insert section

Delete section

Add new section

Section editor: "Edit section" menu

Select "Replace section" to replace the selected section with the copied section

or

Select "Insert section" to additionally add the copied section.

In this case select whether to insert it before or after the selected section.

Insert section

before current section

after current section

Press the **Confirm** icon

9.6.3 Deleting a program section

In the **program view** select the program section to be deleted. The section view opens.



In the **section view** press the **Edit** icon to open the section editor



In the **section editor** select "Delete section" and press the **Confirm** icon.

The section is deleted. The controller returns to the section view.

9.7 Value entry for a program section

Path: [Main menu](#) > [Programs](#) > [Time program](#)

Select the desired program and section.

The section view gives access to all parameters of a program section. You can enter or modify the values.

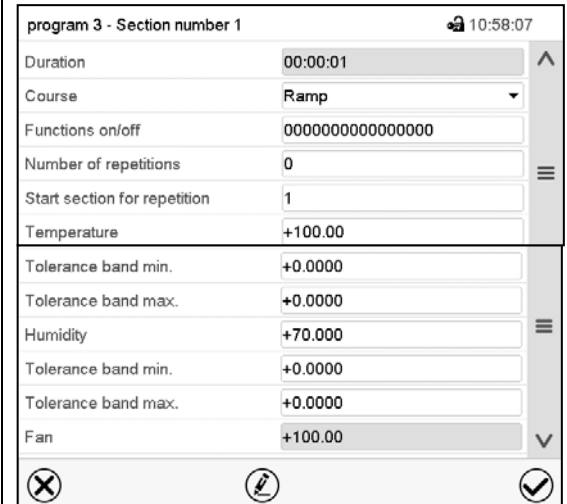
	<table border="1"> <tr> <th colspan="2">Program name and section number</th> </tr> <tr> <td>Section duration</td> <td></td> </tr> <tr> <td>Type of setpoint transition: ramp or step</td> <td></td> </tr> <tr> <td>Operation lines</td> <td></td> </tr> <tr> <td colspan="2">Repeating one or several sections within a program</td> </tr> <tr> <td>Temperature setpoint</td> <td></td> </tr> <tr> <td colspan="2">Temperature tolerance range: minimum and maximum</td> </tr> <tr> <td>Humidity setpoint</td> <td></td> </tr> <tr> <td colspan="2">Humidity tolerance range: minimum and maximum</td> </tr> <tr> <td>Fan speed</td> <td></td> </tr> </table>	Program name and section number		Section duration		Type of setpoint transition: ramp or step		Operation lines		Repeating one or several sections within a program		Temperature setpoint		Temperature tolerance range: minimum and maximum		Humidity setpoint		Humidity tolerance range: minimum and maximum		Fan speed	
Program name and section number																					
Section duration																					
Type of setpoint transition: ramp or step																					
Operation lines																					
Repeating one or several sections within a program																					
Temperature setpoint																					
Temperature tolerance range: minimum and maximum																					
Humidity setpoint																					
Humidity tolerance range: minimum and maximum																					
Fan speed																					

The setting and control ranges for the individual parameters are the same as for “Fixed value” operating mode (chap. 7).

9.7.1 Section duration

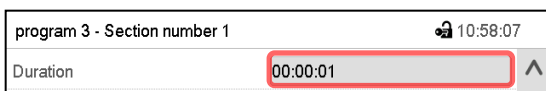

Section view (partial view).

Select the field “Duration” indicating the time.

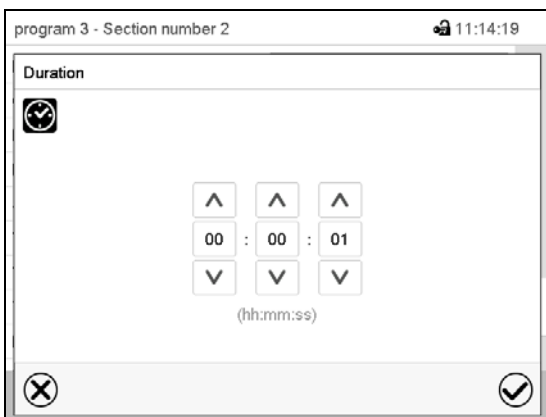

“Duration” entry menu.

Enter the desired section duration with the arrow keys and press the **Confirm** icon.

Setting range: 0 up to 99 hours 59 min 59 sec.

9.7.2 Set-point ramp and set-point step

You can define the type of temperature and humidity transitions for each individual program section.

“Ramp” mode: Gradual changes of temperature and humidity

The set-point of a given program section functions as the section’s start temperature. During the section’s duration, the set-point gradually passes to the set-point of the subsequent program section. The actual value follows the continually changing set-point.

If the last program section is in “ramp” mode and the setpoint shall change within this section, then you must program an additional section (with the shortest possible section duration) to provide the target temperature of the last program section. Otherwise, the setpoint would remain constant during the section’s duration.

Programming in the “ramp” mode allows all kinds of temperature and humidity transitions:

- Gradual changes of temperature and humidity
 The setpoint changes its value gradually during the entered section duration. The actual value follows the continually moving set-point at any time.
- Program sections with constant temperature and humidity
 The setpoints (initial values) of two subsequent program sections are identical; so the temperature and humidity remain constant during the entire duration of the first program section.
- Sudden changes of temperature and humidity
 Steps can be programmed in ramp mode as temperature or humidity changes (ramps) that occur during a very short interval. If the duration of this transitional program section is very short (minimum entry 1 sec), the temperature or humidity change will proceed rapidly within the minimum amount of time.

“Step” mode: Sudden changes of temperature and humidity

The set-point of any program section functions as the section’s target value. At the start of the program section, the cabinet heats up or cools down and humidifies/dehumidifies with the maximum speed to reach the entered value; and then it holds it for the remaining section time. Therefore the set-point temperature remains constant for the section’s duration. These changes occur rapidly within the minimum amount of time (minimum entry: 1 second).

Programming in the “step” mode allows only two kinds of temperature and humidity transitions:

- Programming gradual changes of temperature and humidity (ramps) is impossible in the “step” mode
- Program sections with constant temperature and humidity
 The setpoints (target values) of two subsequent program sections are identical; so the temperature and humidity remain constant during the entire duration of the first program section.
- Sudden changes of temperature and humidity
 The entered setpoint of the section is reached as fast as possible and then held constant for the remaining section duration.

Selecting the setting “Ramp” or “Step”

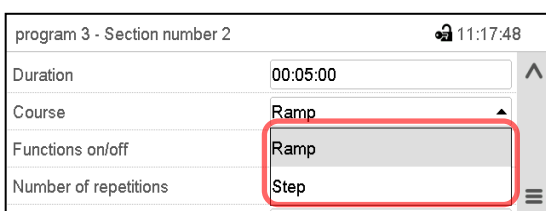

Section view (partial view).

In the field “Course” select the desired setting “Ramp” or “Step”.

“Ramp” and “Step” mode example (representation of a temperature course)

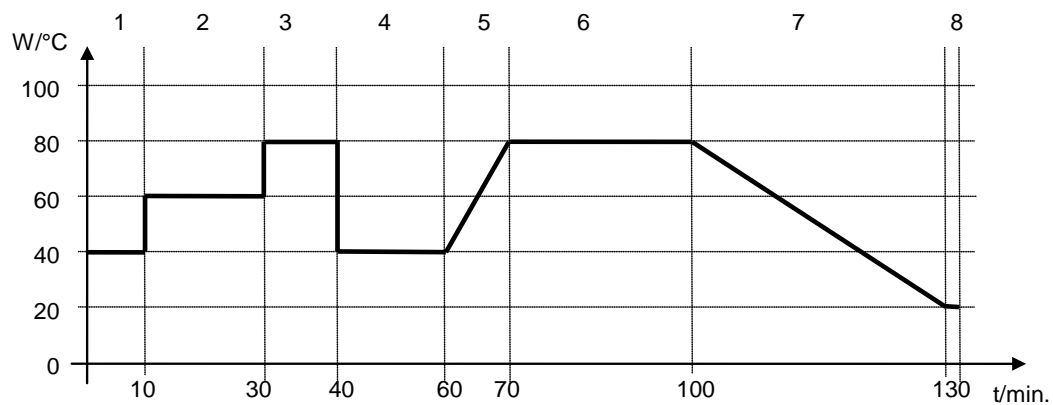

Corresponding program table

Section No.	Duration [hh:mm:ss]	Temperature [°C]	Humidity [% rH]	Fan [%]	Ramp or Step
1	00:10:00	40.0	xxxx	xxxx	Step
2	00:20:00	60.0	xxxx	xxxx	Step
3	00:10:00	80.0	xxxx	xxxx	Step
4	00:20:00	40.0	xxxx	xxxx	Step
5	00:10:00	40.0	xxxx	xxxx	Ramp
6	00:30:00	80.0	xxxx	xxxx	Ramp
7	00:30:00	80.0	xxxx	xxxx	Ramp
8	00:00:01	20.0	xxxx	xxxx	Ramp

9.7.3 Special controller functions via operation lines

You can define the switching state of up to 16 operation lines (control contacts). They are used to activate / deactivate special controller functions.

- Operation line “Humidity off” serves to turn off the humidity.
- Operation line “Idle mode” activates / deactivates the operating mode “Idle mode”.

The other operation lines are without function.

Use the Section editor to configure the operation lines.

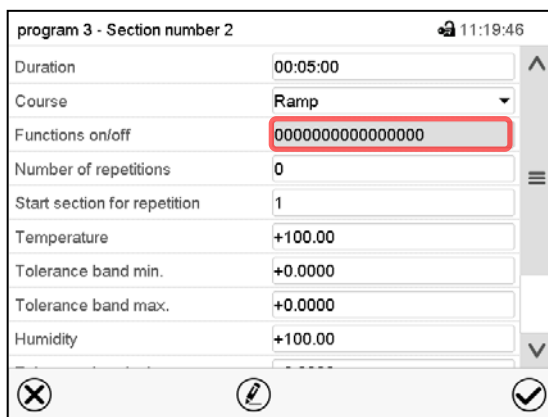

Section view.

Select the field “Functions on/off”.

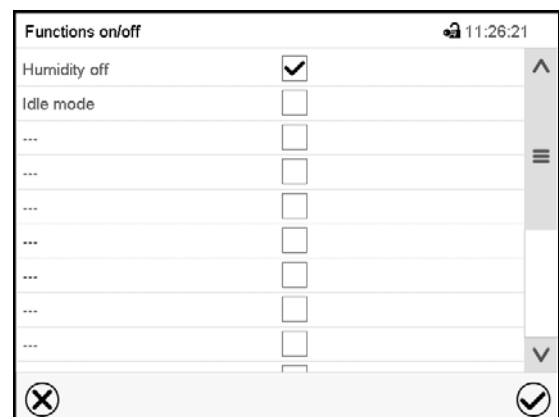

“Functions on/off” entry menu.

Mark / unmark the checkbox of the desired function to activate / deactivate it and press the **Confirm** icon.

The controller returns to the section view.



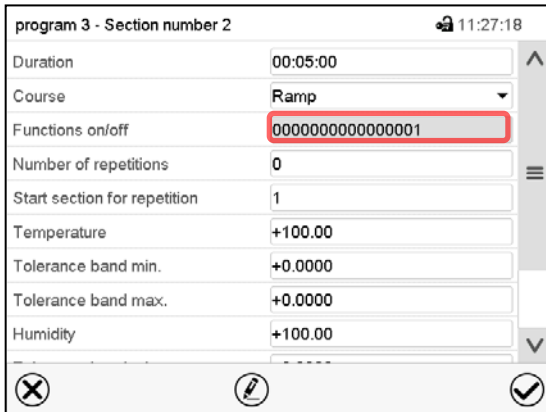

Section view indicating the operation lines.

Activated operation line: switching status “1” (On)

Deactivated operation line: switching status “0” (Off)

The operation lines count from right to left.

Example:

Activated operation line “Humidity off” = 0000000000000001

Deactivated operation line “Humidity off” = 0000000000000000

9.7.4 Setpoint entry

- Select the field “Temperature” and enter the desired temperature setpoint.
 Cabinet without lights: Setting range: -5 °C up to 70 °C.
 Cabinet with lights: Setting range: -5 °C up to 50 °C.
 Confirm entry with **Confirm** icon. The controller returns to the section view.
- Select the field “Humidity” and enter the desired humidity setpoint.
 Cabinet without lights: Setting range: 0% r.H. up to 80% r.H.
 Cabinet with lights: Setting range: 0% r.H. up to 70% r.H.
 Confirm entry with **Confirm** icon. The controller returns to the section view.
- Select the field “Fan” and enter the desired fan speed setpoint.
 Setting range: 40% up to 100% fan speed.
 Confirm entry with **Confirm** icon. The controller returns to the section view.
- Cabinet with lights: Select the field “Light” and enter the desired light intensity setpoint.
 Setting range: 0% up to 100% light intensity. With setting 0% the light is off.
 Confirm entry with **Confirm** icon. The controller returns to the section view.

9.7.5 Tolerance range

You can specify a temperature and humidity program tolerance range for each program section with different values for the tolerance minimum and maximum. When the actual value exceeds the given threshold, the program is interrupted. This is indicated on the display (see below). When the actual temperature is situated again within the entered tolerance limits, the program automatically continues. Therefore, the duration of the program may be extended due to the programming of tolerances.



Programming of tolerances may extend program duration.

An entry of “-99999” for the tolerance minimum means “minus infinite” and an entry of “999999” for the tolerance maximum means “plus infinite”. Entry of these values will never lead to program interruption. The entry of “0” for the tolerance minimum and/or maximum deactivates the respective tolerance function.

When requesting rapid value transitions, we recommend not programming tolerance values in order to enable the maximum heating-up, cooling-down, humidification or dehumidification speed.

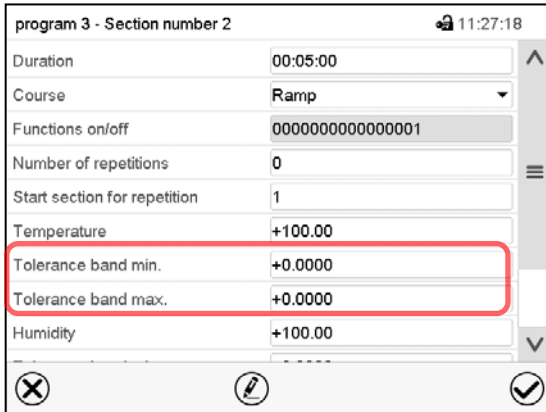

Section view.

- Select the field “Tolerance band min” and enter the desired lower tolerance band value. Setting range: -99999 to 99999. Confirm entry with **Confirm** icon. The controller returns to the section view.
- Select the field “Tolerance band max” and enter the desired upper tolerance band value. Setting range: -99999 to 99999. Confirm entry with **Confirm** icon. The controller returns to the section view.

If one of the actual values (temperature and/or humidity) is outside the program tolerance range the whole program course is interrupted. During this program interruption time the controller equilibrates to the set-points of the current section.

The screen header indicates “Program pause (tolerance band)”. The program runtime indication flashes and does not proceed any further.

When the temperature or humidity values are back within the entered program tolerance range, the program continues automatically.

9.7.6 Repeating one or several sections within a time program

You can repeat several subsequent sections together. It is not possible to define the start section the same time also as the target section, therefore you cannot repeat a single individual section.

Enter the desired number of repetitions in the field „Number of repetitions“ and the number of the section to start the repetition cycle with in the field “Start section for repetition” To have sections repeated infinitely, enter the number of repetitions as “-1”.

The selected sections are repeated as many times as selected. Then the program continues.

Section view.

- Select the field “Number of repetitions” and enter the desired number of repetitions. Setting range: 1 to 99, and -1 for infinite. Confirm entry with **Confirm** icon. The controller returns to the section view.
- Select the field “Start section for repetition” and enter the section number, at which the repetition should start. Setting range: 1 up to the section before the currently selected section. Confirm entry with **Confirm** icon. The controller returns to the section view.

9.7.7 Saving the time program

Section view.

After the all desired values of the program section have been configured, press the **Confirm** icon to take over the programming.

The controller changes to the program view.

No.	Duration [hh:mm:ss]	Temperature [°C]	Humidity [%RH]	Fan [%]	Light [%]
1	00:15:00	30.000	70.000	100.00	80.000
2	03:00:00	50.000	70.000	100.00	100.00
3	01:30:00	50.000	40.000	100.00	50.000
4	00:35:00	15.000	20.000	50.000	100.00
5	05:00:00	40.000	70.000	80.000	0.0000

Program view (example: cabinet with lights).

Press the **Confirm** icon to take over the programming.

The controller changes to the Normal display.

 To save the programming it is absolutely required to press the **Confirm** icon. Otherwise all settings will be lost! There is no confirmation prompt!

10. Week programs

The MB2 program controller permits programming week programs with real-time reference. It offers 5 week program places in total with up to 100 shift points for each week program.

Path: [Main menu > Programs > Week program](#)

10.1 Starting an existing week program

 In Normal display press the **Program start** icon to access the “Program start” menu.

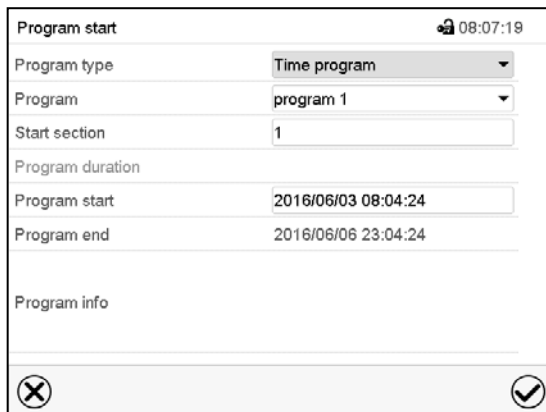

“Program start” menu.

- In the field “Program type” select the setting “Week program”.
- In the field “Program” select the desired program.
- There are no further settings available in the “Program start” menu for week programs, as they are needed only for time programs.

After completing the settings, press the **Confirm** icon to take over the entries and exit the menu. The program starts running.

If instead you press the **Close** icon to exit the menu without taking over the entries, the program will not start.

After starting the week program, the previously entered week program setpoints are active and will be equilibrated according to the current time.

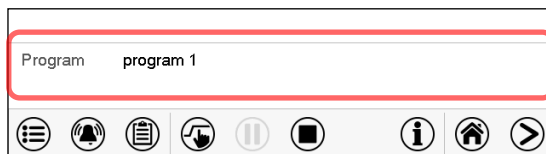

Information on the bottom of the screen indicates the currently running program.

10.2 Cancelling a running week program

 Press the **Program cancelling** icon to cancel the program.

A confirmation prompt is displayed. Press the **Confirm** icon to confirm that the program shall really be cancelled.

After confirming the message the controller changes to Fixed value operation mode. Temperature and humidity will then equilibrate to the setpoints of Fixed value operation mode.

10.3 Creating a new week program

Path: *Main menu > Programs > Week program*

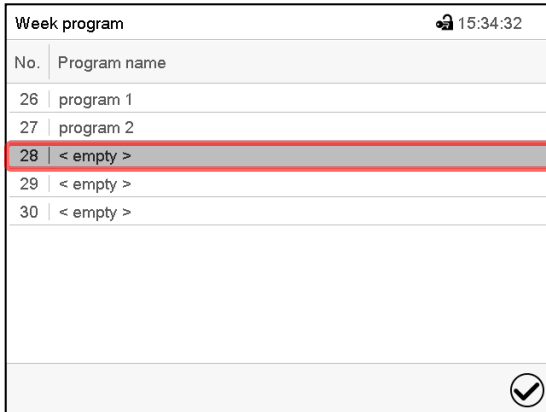

“Week program” menu: overview of the existing programs. Select an empty program place.

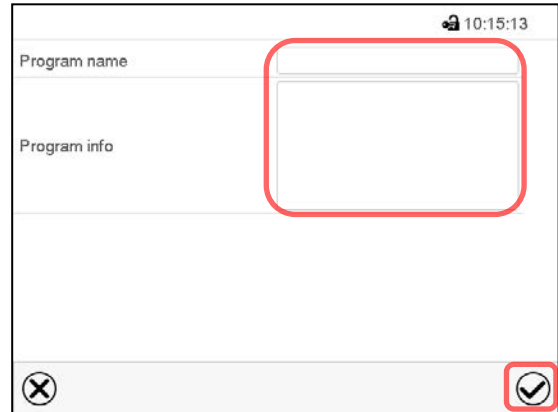

Enter the program name and, if desired, additional program information in the corresponding fields. Press the **Confirm** icon. The program view opens.

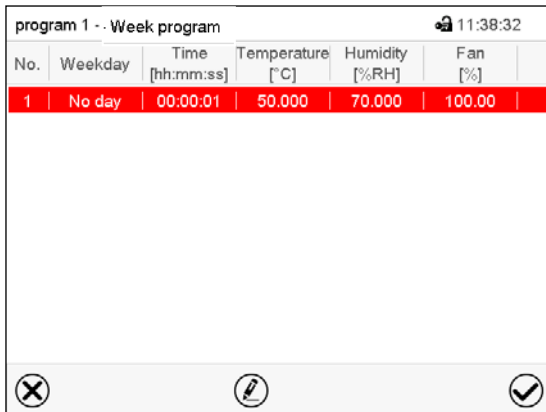

Program view.

For the first section no weekday is specified. Therefore the section is first marked in red and cannot be saved.

Note for cabinet with lights: The light setpoint is not visible in the week program view.

10.4 Program editor: program management

Path: *Main menu > Programs > Week program*

No.	Program name
26	program 1
27	program 2
28	< empty >
29	< empty >
30	< empty >

“Week program” menu:
overview of the existing programs.

Select an existing program (example: program 1).



No.	Weekday	Time [hh:mm:ss]	Temperature [°C]	Humidity [%RH]	Fan [%]
1	Monday	07:00:00	30.000	70.000	80.000
2	Wednesday	15:30:00	50.000	40.000	100.000

Program view (example: program 1).

If a new program has been created, there is just one program section.

There are the following options:

- ① Select a program section to open the section editor (chap. 0)
- ② Press the **Edit** icon to open the program editor



Edit program	
Change program name	
Copy program	
Delete program	
Add new section	

Program editor: “Edit program” menu.

Select the desired function and press the **Confirm** icon.

The program editor offers following options:

- Change program name. This menu also offers to configure the ramp / step mode setting (chap. 10.6.1).
- Copy program
- Replace program: Replacing an new or an existing program with the copied program. This menu point is visible only after a section has been copied.
- Delete program
- Add new section

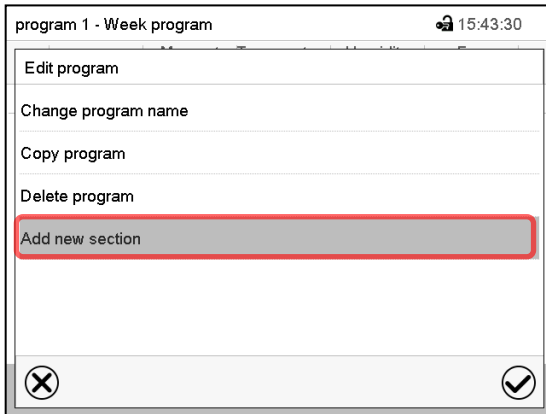

To add a new section, select “Add new section” and press the **Confirm** icon.

The program view opens.

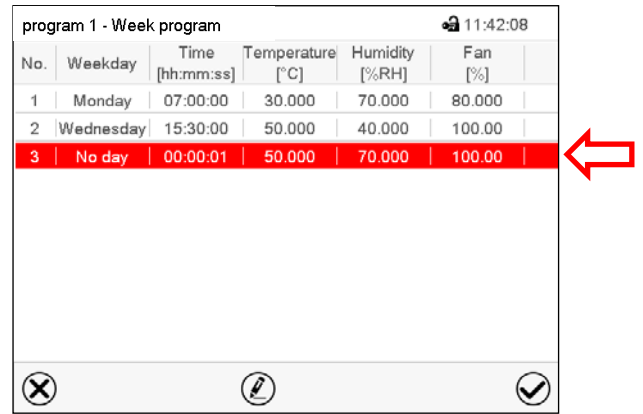

Program view.

With a new section no weekday is specified. Therefore the section is first marked in red and cannot be saved.

A new section is always added at the very bottom (example: section 3). When the section start is specified the sections are automatically arranged in the correct chronological order.

10.4.1 Deleting a week program

Path: [Main menu](#) > [Programs](#) > [Week program](#)

In the “Week program” menu select the program to be deleted. The program view opens.

In the **program view** press the **Edit** icon to open the program editor

In the **program editor** select “Delete program” and press the **Confirm** icon.

The program is deleted. The controller returns to the program view.

10.5 Section editor: Section management

Path: [Main menu](#) > [Programs](#) > [Week program](#)

Select the desired program.

No.	Weekday	Time [hh:mm:ss]	Temperature [°C]	Humidity [%RH]	Fan [%]
1	Monday	07:00:00	30.000	70.000	80.000
2	Wednesday	15:30:00	50.000	40.000	100.00

Program view.

Select the desired program section (example: section 1)



Section view (example for cabinet with lights)

There are the following options:

- ① Select a parameter to enter or modify the according value (chap. 10.6)
- ② Press the **Edit** icon to open the program editor

Section editor: "Edit section" menu

Select the desired function and press the **Confirm** icon.

The section editor offers following options:

- Copy section
- Replace section: Replacing an existing section with the copied section. This menu point is visible only after a section has been copied.
- Insert section: Adding the copied section. This menu point is visible only after a section has been copied.
- Delete section
- Add new section

10.5.1 Add a new program section

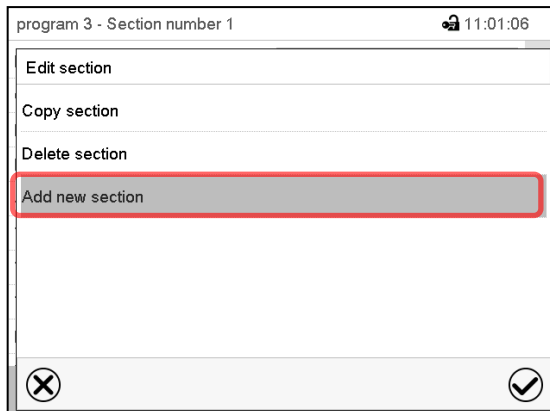

Section editor: "Edit section" menu.

Select "Add new section" and press the **Confirm** icon.



No.	Weekday	Time [hh:mm:ss]	Temperature [°C]	Humidity [%RH]	Fan [%]
1	Monday	07:00:00	30.000	70.000	80.000
2	Wednesday	15:30:00	50.000	40.000	100.000
3	No day	00:00:01	50.000	70.000	100.000

Program view.

With a new section no weekday is specified. Therefore the section is first marked in red and cannot be saved.

A new section is always added at the very bottom (example: section 3). When the section start is specified the sections are automatically arranged in the correct chronological order.

10.5.2 Copy and insert or replace a program section

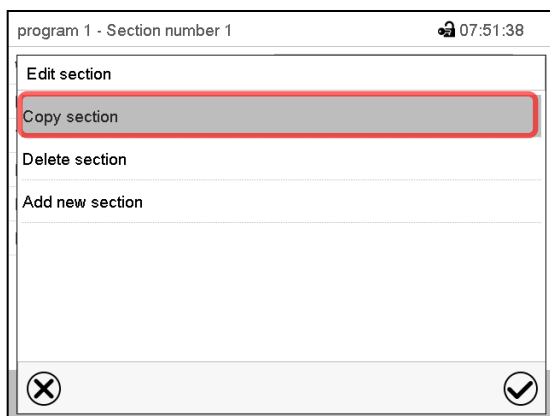

Section editor: "Edit section" menu

Select "Copy section" and press the **Confirm** icon.

The current section (example: section 1) is copied.

The controller returns to the program view.



No.	Weekday	Time [hh:mm:ss]	Temperature [°C]	Humidity [%RH]	Fan [%]
1	Monday	07:00:00	30.000	70.000	80.000
2	Wednesday	15:30:00	50.000	40.000	100.000

Program view

Select the section to be replaced or before or after which the copied section shall be inserted (example: section 2).

Press the **Confirm** icon

The controller returns to the section editor



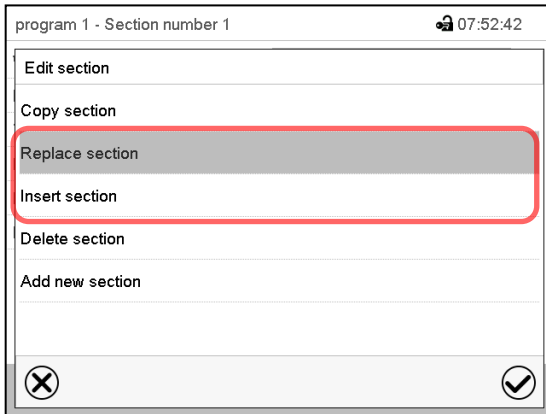

Section editor: "Edit section" menu

Select "Replace section" to replace the selected section with the copied section

or

Select "Insert section" to additionally add the copied section.

Press the **Confirm** icon.

If you selected "Insert section" the sections are automatically arranged in the correct chronological order.

10.5.3 Deleting a program section

In the **program view** select the program section to be deleted. The section view opens.



In the **section view** press the **Edit** icon to open the section editor



In the **section editor** select "Delete section" and press the **Confirm** icon.

The section is deleted. The controller returns to the section view.

10.6 Value entry for a program section

Path: [Main menu > Programs > Week program](#)

Select the desired program and section.

The setting and control ranges for the individual parameters are the same as for "Fixed value" operating mode (chap. 7).

10.6.1 Set-point ramp and set-point step modes

The explanation of the settings "Ramp" or "Step" is given in chap. 9.7.2.

You can define the type of temperature and humidity transitions for the entire week program.

Select the desired program and press the **Edit** icon to open the program editor. In the program editor select the "Change program name" function and press the **Confirm** icon.

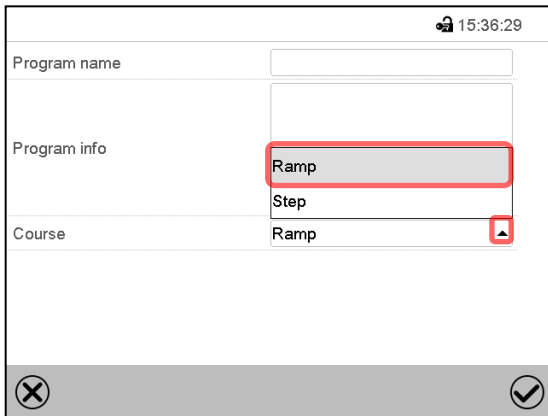

“Change program name” menu.

In the field “Course” select the desired setting “Ramp” or “Step” and press the **Confirm** icon.

10.6.2 Weekday

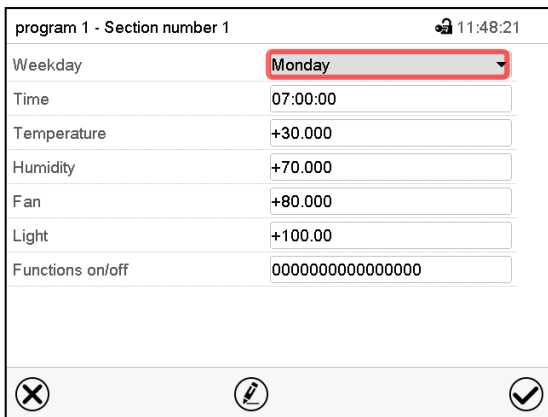

In the field “Weekday” select the desired weekday.

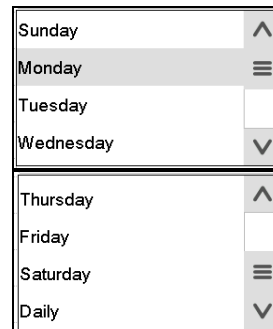

With “Daily” selected, this section will run every day at the same time.

Section view (example: cabinet with lights).

10.6.3 Start time

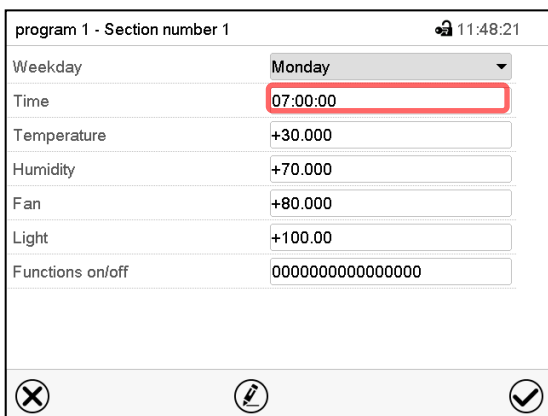

Section view (example: cabinet with lights).

Entry menu “Moment”.

Select the field “Moment”.

Select with the arrow keys the desired start moment of the section and press the **Confirm** icon.

10.6.4 Setpoint entry

- Select the field “Temperature” and enter the desired temperature setpoint.
Cabinet without lights: Setting range: -5 °C up to 70 °C.
Cabinet with lights: Setting range: -5 °C up to 50 °C.
Confirm entry with **Confirm** icon. The controller returns to the section view.
- Select the field “Humidity” and enter the desired humidity setpoint.
Cabinet without lights: Setting range: 0% r.H. up to 80% r.H.
Cabinet with lights: Setting range: 0% r.H. up to 70% r.H.
Confirm entry with **Confirm** icon. The controller returns to the section view.
- Select the field “Fan” and enter the desired fan speed setpoint.
Setting range: 40% up to 100% fan speed.
Confirm entry with **Confirm** icon. The controller returns to the section view.
- Cabinet with lights: Select the field “Light” and enter the desired light intensity setpoint.
Setting range: 0% up to 100% light intensity. With setting 0% the light is off.
Confirm entry with **Confirm** icon. The controller returns to the section view.

10.6.5 Special controller functions via operation lines

You can define the switching state of up to 16 operation lines (control contacts). They are used to activate / deactivate special controller functions.

- Operation line “Humidity off” serves to turn off the humidity.
- Operation line “Idle mode” activates / deactivates the operating mode “Idle mode”.

The other operation lines are without function.

Select the desired program and section. You can set the operation lines in the “Functions on/off” field.

For details please refer to chap. 9.7.3.

11. Notification and alarm functions

11.1 Notification and alarm messages overview

11.1.1 Notifications

Notifications are indicated by **information icons** displayed in the screen header in Normal display

An information icon serves as an indication of a certain condition.



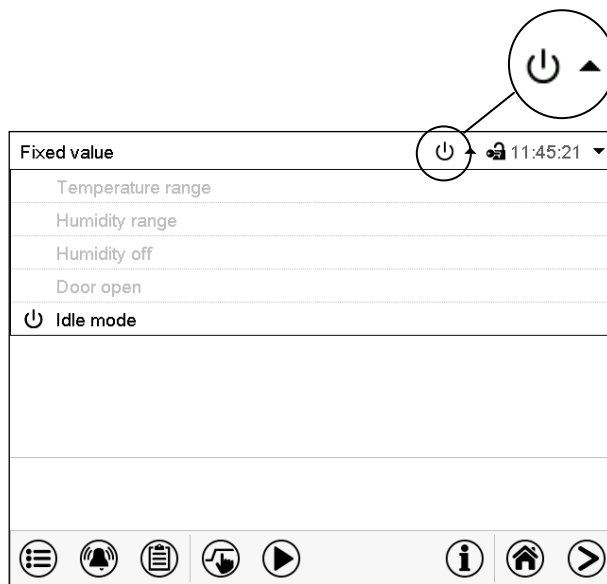

If this condition persists, in some cases an alarm will be triggered after a fix or configurable interval. As long as the condition persists, the information icon therefore continues to be displayed also in state of alarm. If during alarm the conditions ends, e.g., if during a tolerance range alarm the actual value returns to within the tolerance range, the information icon disappears, whereas the alarm will continue until manual acknowledgement.

Press the flash icon next to the information icon to access the corresponding text information.



Normal display showing the text information.

The currently valid information texts are highlighted in black (example: **Idle mode**)

Condition	Information icon	Text information	Start after condition occurred
The controller is in Idle mode (chap. 5.4).		"Idle mode"	immediately
The current actual temperature value is outside the tolerance range (chap. 11.4)		"Temperature range"	immediately
The current actual humidity value is outside the tolerance range (chap. 11.4)		"Humidity range"	immediately
The humidification / dehumidification system is turned off (via operation line and/or by setting "Control on/off") or Temperature setpoint below 0 °C or above 95 °C		"Humidity off"	immediately
Cabinet door open		"Door open"	immediately

Notifications are not shown in the event list.

11.1.2 Alarm messages

Condition	Alarm message	Start after condition occurred	Zero-voltage relay alarm output (option)
The current actual temperature value is outside the tolerance range (chap. 11.4)	"Temperature range	after configurable time	time as alarm start
The current actual humidity value is outside the tolerance range (chap. 11.4)	"Humidity range	after configurable time	time as alarm start
Cabinet door open	"Door open	after 5 minutes	----
Power failure	---	----	immediately
Exceeded setpoint of the safety controller class 3.1	"Safety controller	immediately	----
Temperature sensor defective	e.g. "- - - - " or "<-<-< " or ">->->"	immediately	----
Safety controller temperature sensor defective	Safety controller sensor	immediately	----

Alarm messages are displayed in the list of active alarms until acknowledging them. They are also shown in the event list.

11.1.3 Messages concerning the humidity system

Condition and measures	Message	Start after condition occurred
The humidity module is defective. Contact your local Datacolor service representative.	"Humidity system"	immediately
The humidity module cannot fill up. <i>In case of freshwater supply via water pipe:</i> The water tap is closed, or the cabinet is defective (e.g. inlet valve of humidity module). <i>In case of freshwater supply via freshwater can (option, chap. 4.5):</i> Water can is empty. Humidification is turned off. In case of refrigerating operation, the interior is strongly dehumidified. When the water supply is functional again, the humidity system restarts, or the cabinet is defective.	"Freshwater supply"	immediately
The humidity module cannot empty the condensate tank. Wastewater tube obstructed. Check the length and location of the wastewater tube. If appropriate contact your local Datacolor service representative.	"Waste water"	immediately
Purging is required soon. Turn off and on again the humidity switch to start purging. After a successful purging the notification resets automatically.	"Humidity system purging req."	after predefined time (approx. 3-5 months depending on use)
Maintenance of the humidity system is required. Contact your local Datacolor service representative.	"Humidity module service"	after predefined time (approx. 1 year)

Messages concerning the humidity system are shown in the event list.

 When operating the cabinet without water connection, turn off humidity control in the “set-points” menu (chap. 6.3) in order to avoid humidity alarms.

11.2 State of alarm

1. Visual indications in Normal display: alarm message, screen header flashing in red color
2. Audible alert, if the buzzer is enabled (chap. 11.5).

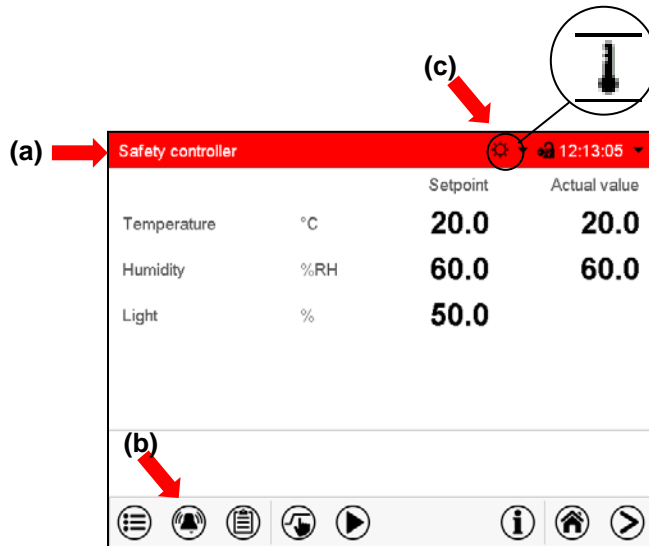

Normal display in state of alarm (example for cabinet with lights).

- (a) Screen header flashing in red color and showing the alarm message
- (b) **Alarm** icon on the bottom of the screen: change to the list of active alarms and alarm acknowledgement
- (c) If applicable, information icon in the screen header. Indication of a certain condition

11.3 Resetting an alarm, list of active alarms

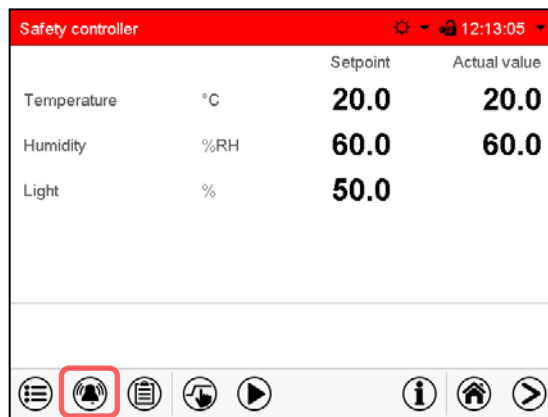

Normal display in state of alarm (example for cabinet with lights).

Press the **Alarm** icon

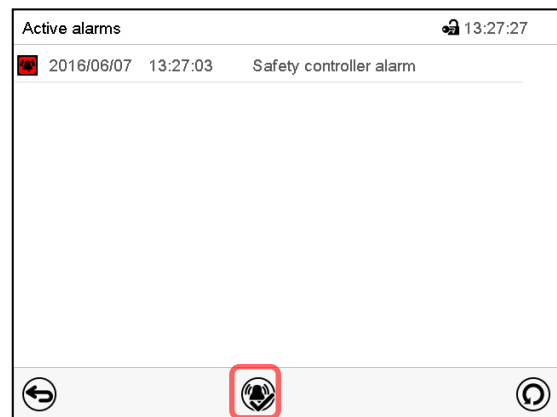

List of active alarms.

Press the **Reset alarm** icon.

Pressing the **Reset alarm** icon mutes the buzzer for all active alarms. The icon then disappears.

- Acknowledging while the alarm condition persists: Only the buzzer turns off. The visual alarm indication remains on the controller display. The alarm remains in the list of active alarms.

When the alarm condition has ended, the visual alarm indication is automatically cleared. The alarm is then no longer in the list of active alarms.

- Acknowledging after the alarm condition has ended: The buzzer and the visual alarm indication are reset together. The alarm is then no longer in the list of active alarms.
- The zero-voltage relay alarm output resets together with the alarm.

11.4 Tolerance range settings

In this menu you can set the deviation between the actual value and setpoint which shall cause a tolerance range alarm.

This function only activates after the set-point has been reached once.

Path: [Main menu](#) > [Settings](#) > [Various](#)

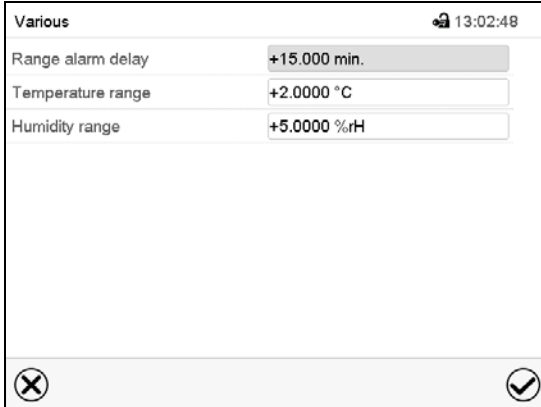



Submenu "Various".

- Select the field "Range alarm delay" and enter the time in minutes, after which the range alarm shall be triggered. Setting range: 15 min to 120 min. Confirm entry with **Confirm** icon.
- Select the field "Temperature range" and enter the desired value for the temperature range. Setting range: 2 °C to 10 °C. Confirm entry with **Confirm** icon.
- Select the field "Humidity range" and enter the desired value for the humidity range. Setting range: 5% r.H. to 20% r.H. Confirm entry with **Confirm** icon.

After completing the settings, press the **Confirm** icon to take over the entries and exit the menu, **or** press the **Close** icon to exit the menu without taking over the entries.

If there are actual values outside the tolerance range the following information icons for the corresponding parameter are displayed:

Icon	Signification	Information
	"Temperature range"	The temperature value is outside the tolerance range
	"Humidity range"	The humidity value is outside the tolerance range

If the condition persists, an alarm is triggered after the configured interval ("range alarm delay"). It is visually indicated in Normal display. If the alarm buzzer is activated (chap. 11.5) there is an audible alert. The alarm is shown in the list of active alarms (chap. 11.3).

11.5 Activating / deactivating the audible alarm (alarm buzzer)

Path: [Main menu](#) > [Settings](#) > [Chamber](#)

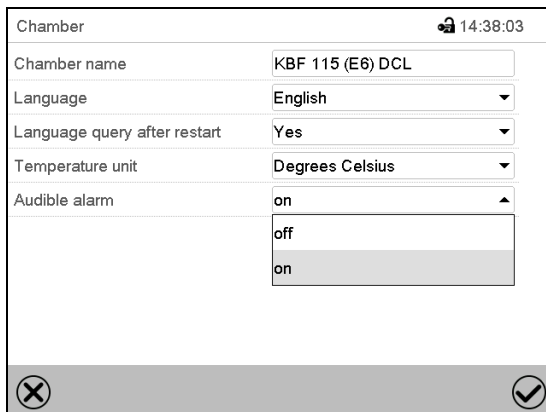

Chamber	
Chamber name	KBF 115 (E6) DCL
Language	English
Language query after restart	Yes
Temperature unit	Degrees Celsius
Audible alarm	on
	off
	on

“Chamber” submenu (example).

In the field “Audible alarm” select the desired setting “off” or “on” and press the **Confirm** icon.

12. Temperature safety devices

12.1 Over temperature protective device (class 1)

The cabinet is equipped with an internal temperature safety device, class 1 acc. to DIN 12880:2007. It serves to protect the cabinet and prevents dangerous conditions caused by major defects.

- Cabinet without lights: limit temperature approx. 110 °C / 230 °F
- Cabinet with lights: limit temperature approx. 90 °C / 194 °F

If this limit temperature is reached, the over temperature protective device permanently turns off the cabinet. The user cannot restart it. The protective cut-off device is located internally. Only a service specialist can replace it. Therefore, please contact an authorized service provider or your local Datacolor service representative.

12.2 Overtemperature safety controller class 3.1

The cabinets are regularly equipped with an electronic overtemperature safety controller (temperature safety device class 3.1 according to DIN 12880:2007). The safety controller is functionally and electrically independent of the temperature control system. If an error occurs, it performs a regulatory function.

The overtemperature safety controller serves to protect the cabinet, its environment and the contents from exceeding the maximum permissible temperature. In the case of an error, it limits the temperature inside the cabinet to the entered safety controller set-point. This condition (state of alarm) is indicated visually and additionally with an audible alert if the buzzer is enabled (chap. 11.5). The alarm persists until the cabinet cools down below the configured safety controller setpoint.

	Check the setting regularly and adjust it following changes of the set-point or charge.
---	---

	The safety controller only activates after the set-point has been reached once.
---	---

12.2.1 Safety controller modes

You can select between “Limit (absolute)” and “Offset (relative)” safety controller mode

- **Limit:** Absolute maximum permitted temperature value

This setting offers high safety as a defined temperature limit will not be exceeded. It is important to adapt the safety controller set-point after each modification of the temperature set-point. Otherwise, the limit could be too high to ensure efficient protection, or, in the opposite case, it could prevent the controller from reaching an entered set-point outside the limit range.

- **Offset:** Maximum overtemperature above any active temperature set point. The maximum temperature changes internally and automatically with every set-point change.

This setting is recommended for program operation. It is important to check the safety controller set-point and safety controller mode occasionally, as it does not offer a fix, independent limit temperature value, which would never be exceeded.

Example: Desired temperature value: 21 °C, desired safety controller value: 25 °C.
Possible settings for this example:

Temperature set point	Safety controller mode	Safety controller set-point
21 °C	Limit (absolute)	25 °C
	Offset (relative)	4 °C

12.2.2 Setting the safety controller

 Press the **Setpoint setting** icon to access the “Setpoint” setting menu from Normal display.

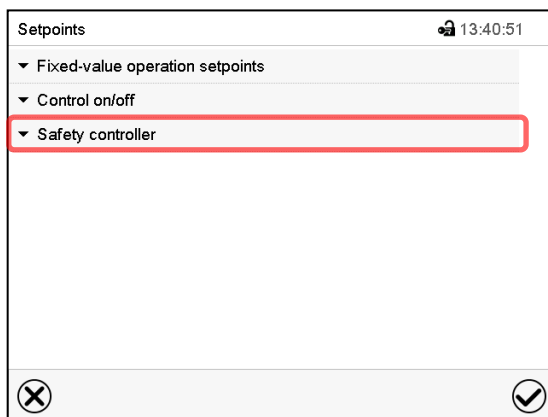

“Setpoints” menu.

Select the field “Safety controller” to access the settings.

- In the field “Mode” select the desired setting “Limit” or “Offset”.

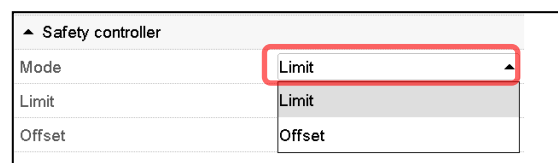

- Select the corresponding field “Limit” **or** “Offset” according to the selected mode and enter the desired safety controller setpoint. Confirm entry with **Confirm** icon.

	<p>Regularly check the safety controller setting for set-point type “Limit” or “Offset”</p> <ul style="list-style-type: none"> • in Fixed value operating mode according to the entered set-point temperature value • in program mode according to the highest temperature value of the selected temperature program <p>Set the safety controller set-point by approx. 2 °C to 5 °C above the desired temperature set-point.</p>
---	--

After completing the settings, press the **Confirm** icon to take over the entries and exit the menu, **or** press the **Close** icon to exit the menu without taking over the entries.

12.2.3 Message and measures in the state of alarm

The state of alarm is indicated visually in Normal display by the alarm message “Safety controller alarm” and the screen header flashing in red color. If the buzzer is enabled (chap. 11.5) there is an additional audible alert (chap. 11.2). The alarm remains active until it is acknowledged on the controller and the inner temperature falls below the set safety controller setpoint. Then the heating is released again.

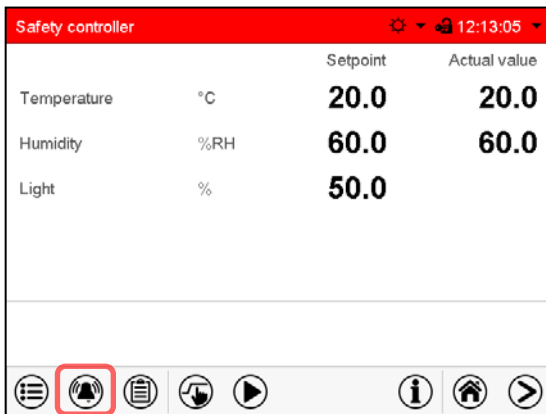

Normal display with safety controller alarm (example for cabinet with lights).

Press the **Alarm** icon

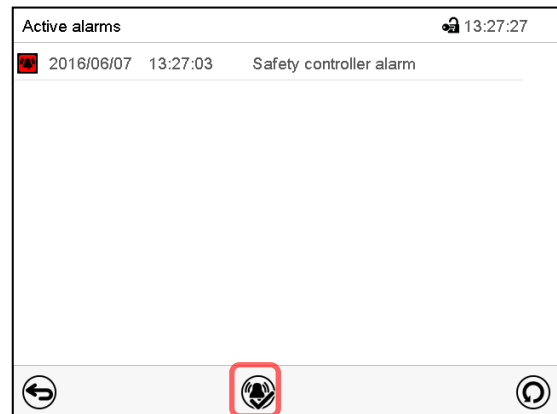

List of active alarms.

Press the **Reset alarm** icon.

12.2.4 Function check

Check the safety controller at appropriate intervals for its functionality. It is recommended that the authorized operating personnel should perform such a check, e.g., before starting a longer work procedure.

13. User management

13.1 Authorization levels and password protection

The available functions depend on the current authorization level “Master”, “Service”, “Admin” or “User”.

The authorization levels are hierarchical: Every authorization includes all functions of the next lower level.

“Master” authorization level

- Highest authorization level, only for developers
- Extensive authorization for controller operation and configuration, outputs/inputs, alarm settings, parameter sets and operating ring display
- All passwords can be changed in the “log out” submenu (chap. 13.3).

“Service” authorization level

- Authorization level only for Datacolor service
- Extensive authorization for controller operation and configuration, access to service data
- The passwords for “Service”, “Admin” and “User” authorization levels can be changed in the “log out” submenu (chap. 13.3).

“Admin” authorization level

- Expert authorization level, for the administrator
- Authorization for controller configuration and network settings and for operating those controller functions required for operating the cabinet. Restricted access to service data.
- Password (factory setting): “2”.
- The passwords for “Admin” and “User” authorization levels can be changed in the “log out” submenu (chap. 13.3).

“User” authorization level

- Standard authorization level for the cabinet operator
- Authorization for operating the controller functions required for operating the cabinet.
- No authorization for controller configuration and network settings. The “Settings” and “Service” submenus of the main menu are not available.
- Password (factory setting): “1”
- The password for the “User” authorization level can be changed in the “log out” submenu (chap. 13.3).

As soon as a password has been assigned for an authorization level, the access to this level and the related controller functions are only available after log-in with the appropriate password.

If for an authorization level no password is assigned, the related controller functions of this level are available for every user without login.

If passwords have been assigned for all authorization levels, access to the controller functions is locked without login.

Operation after user login

At user login, the authorization level is selected and confirmed by entering the respective password.

Following user login, controller operation is available, recognizable by the open-lock icon in the header. The available controller functions correspond to the user's authorization level.

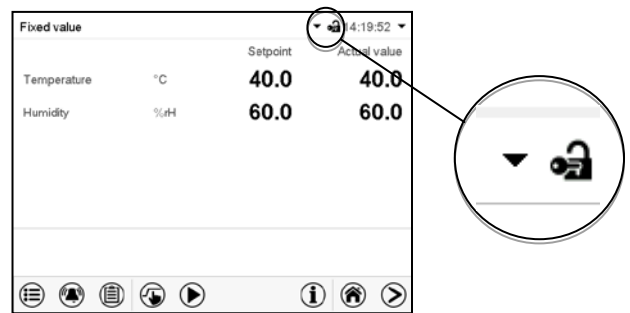

Example: cabinet without lights

Password protection activated for all levels: operation without user login is locked

If passwords have been assigned for all authorization levels, the controller is locked without registration of a user.

As long as no user is registered, controller operation is locked, recognizable at the closed-lock icon in the header. This requires that the user management has been activated by the assignment of passwords for the individual authorization levels.



Example: cabinet without lights

Password protection for at least one level deactivated: operation without user login is possible

If passwords have not been assigned for all authorization levels, after turning on the cabinet there are those controller functions available, which correspond to the highest authorization level without password protection.

No lock icon is shown in the display header.

User login is neither required nor possible.

To activate the password protection and user login, perform new password assignment (chap. 13.5.3).

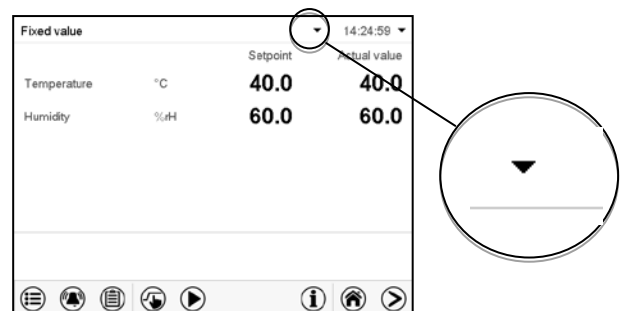

Example: cabinet without lights

Information window

To check the authorization level of the user currently logged-in, select in Normal display the arrow far right in the display header.

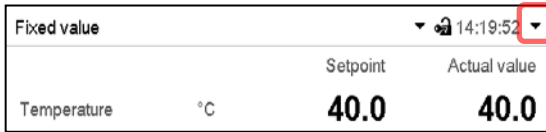

The information window shows date and time, the controller's free memory space and under "Authorization" the authorization level of the current user.

If passwords have been assigned for all authorization levels, a user without login (password entry) has no authorization. There are only viewing functions available.

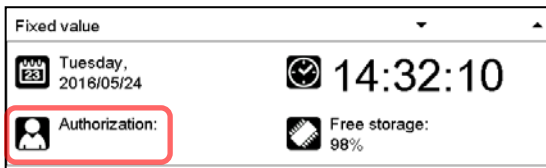

Display when all authorization levels are password protected and no user has logged in:

No authorization level is displayed.

If passwords have been assigned only for some of the authorization levels, a user without login (password entry) has access to the functions of the highest authorization level without password protection.



Display when only some of the authorization levels are password protected (example: no protection for the "User" and "Admin" levels) and no user has logged in:

The user's effective authorization (due to lack of password protection) is shown.

Example: user with "Admin" authorization.

If passwords have been assigned for some or all of the authorization levels, user login (password entry) provides the authorization for the corresponding password-protected level.



Display when at least some of the authorization levels are password protected and a user has logged in.

The user's authorization (by password entry) is shown.

Example: user with "Admin" authorization.

13.2 Log in

Path: *Main menu > User > Log in*

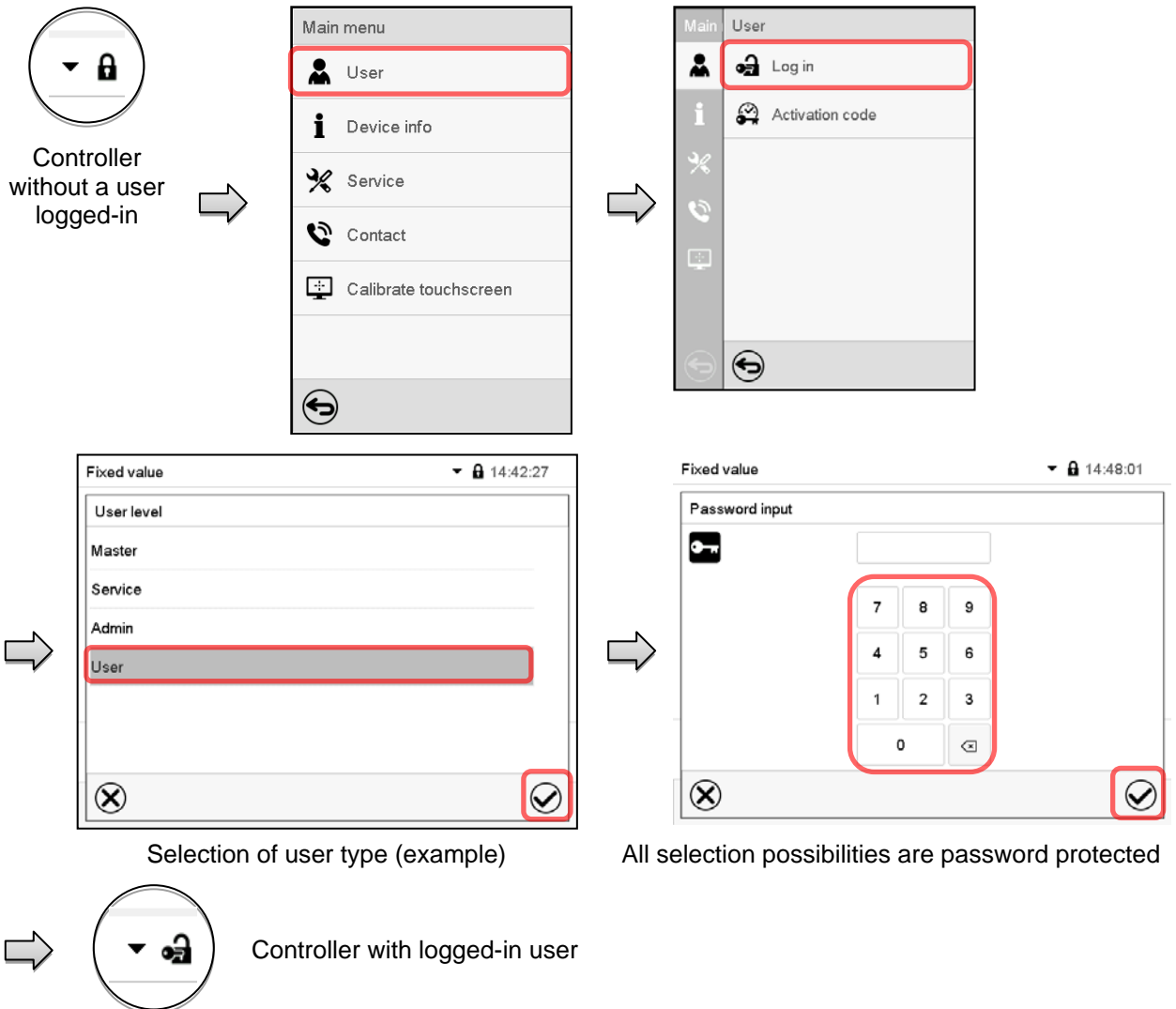

After completing the settings, press the **Confirm** icon to take over the entries and exit the menu, **or** press the **Close** icon to exit the menu without taking over the entries.

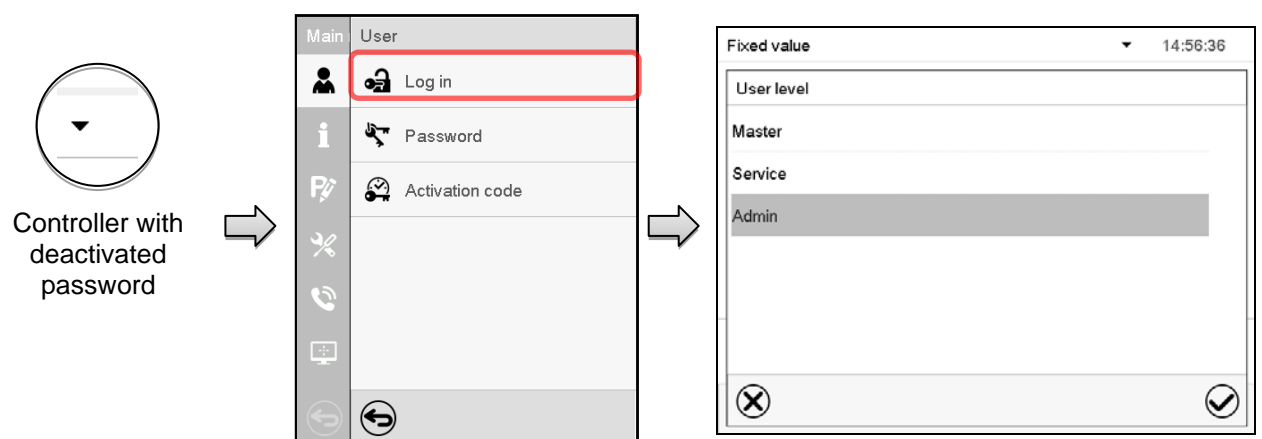

13.3 Log out

Path: *Main menu > User > Log out*

User logoff with “Admin” authorization

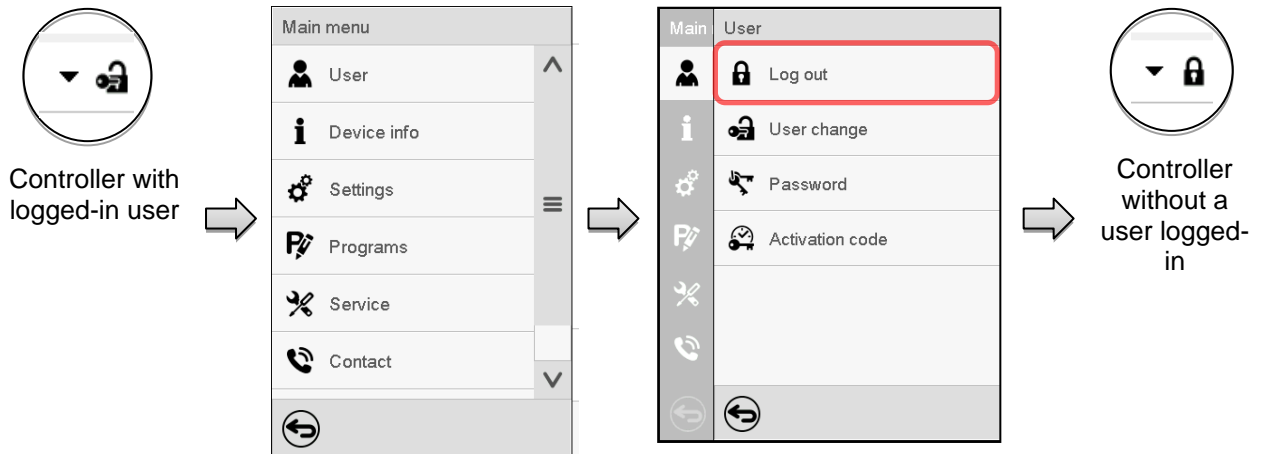

User logoff with “Admin” authorization

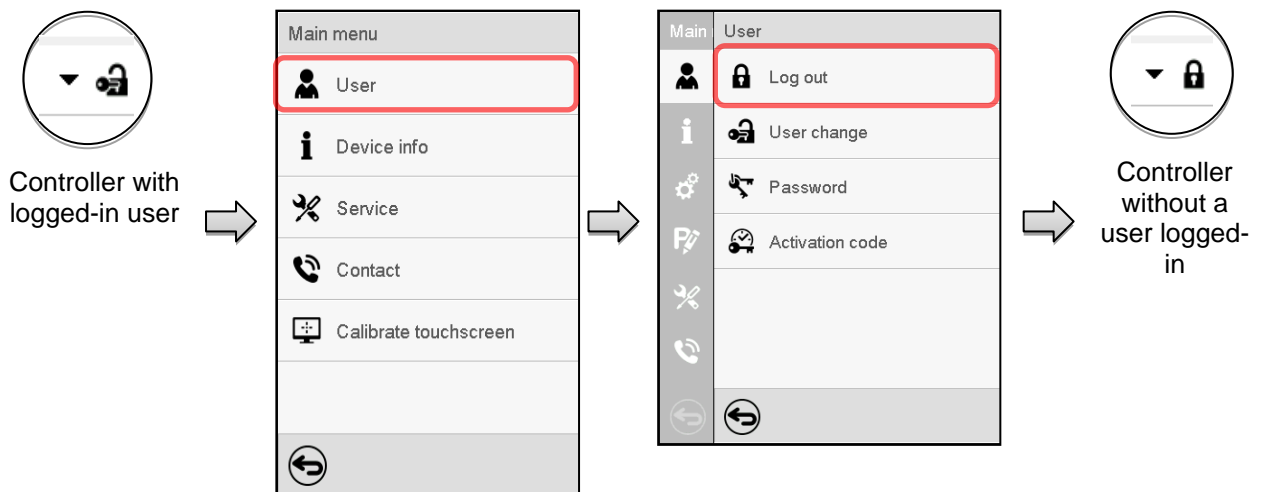

13.4 User change

If the password function has been deactivated (chap.13.5.2) this function is not available.

Path: *Main menu > User > User change*

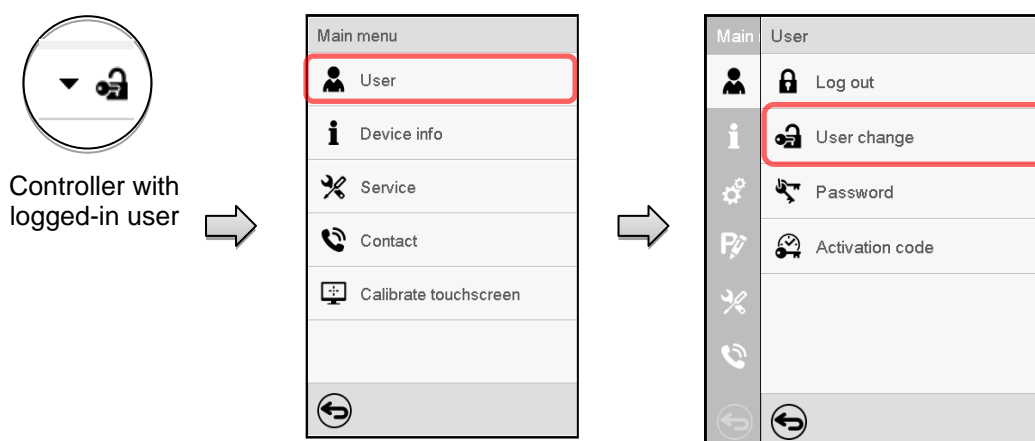

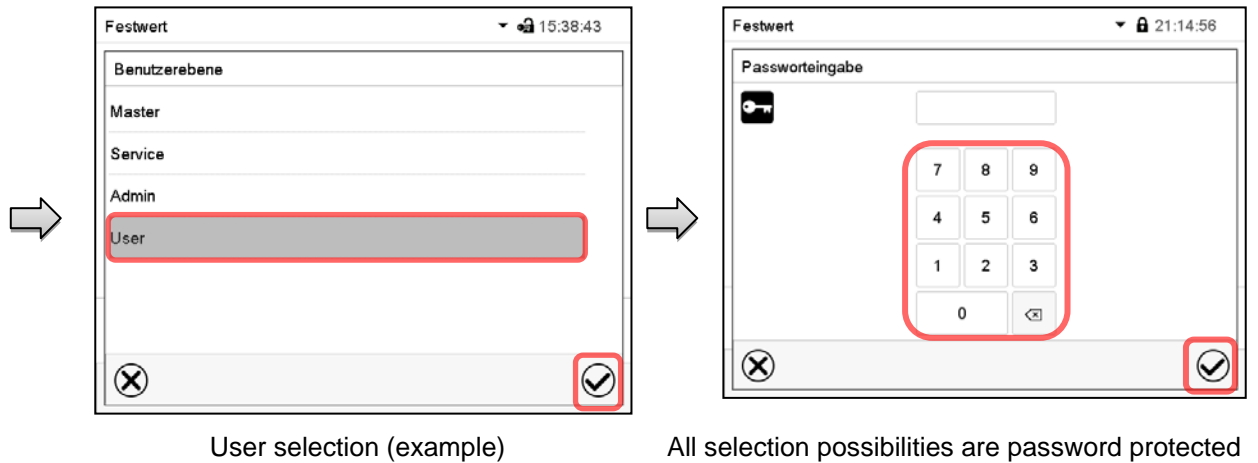

13.5 Password assignment and password change

This function is not available for a user logged-in with "User" authorization.

13.5.1 Password change

A logged-in user can change the passwords of his current level and of the next lower level(s).

Example: A user with "Admin" authorization can change the passwords for the "Admin" and "User" authorization levels.

Path: *Main menu > User > Password*

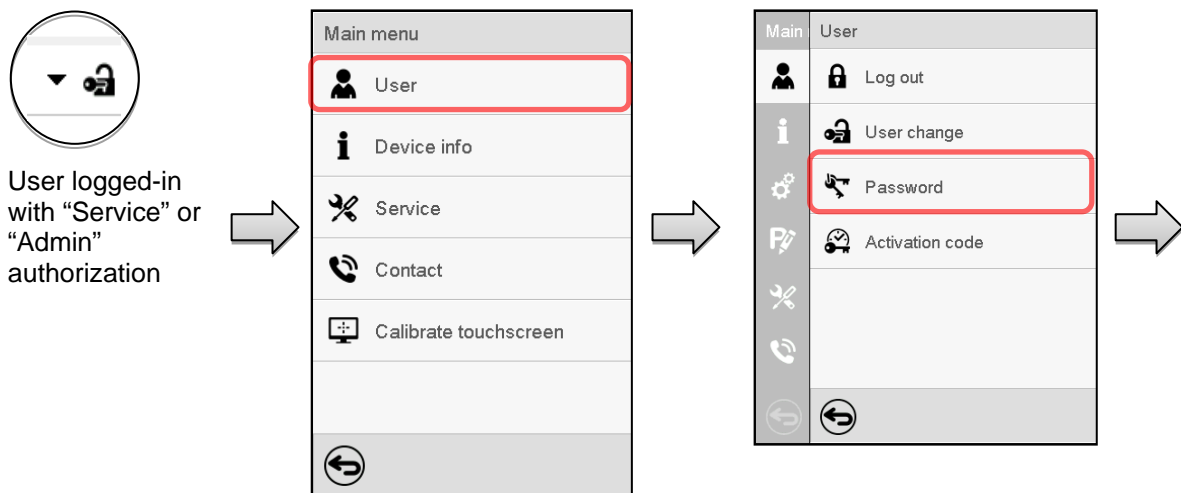



Selection of the authorization level (example: view with "Admin" authorization)

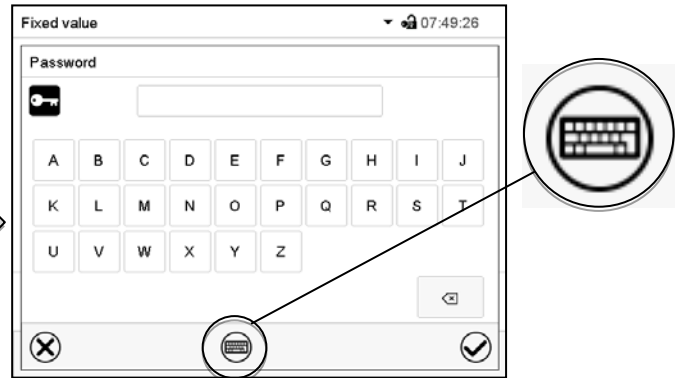

Enter desired password. If desired, press the **Change keyboard** icon to access other entry windows.

In the "Keyboard switch" window you can select different keyboards to enter uppercase and lowercase letters, digits, and special characters. All types of characters can be combined within one single password.

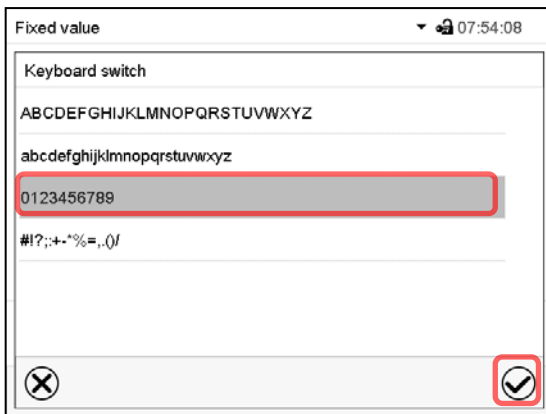

Example: access the digit entry window

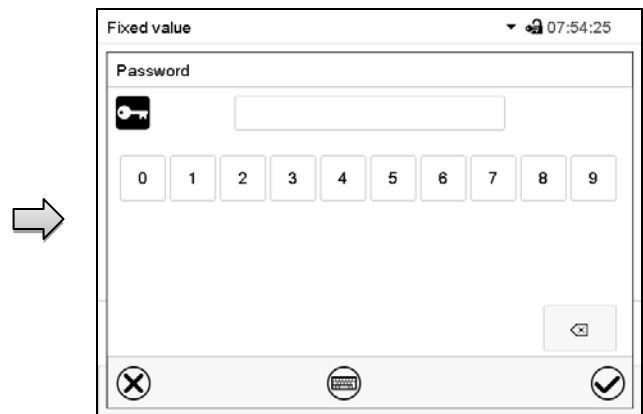

Entry of digits

To confirm the entry, press the **Confirm** icon.

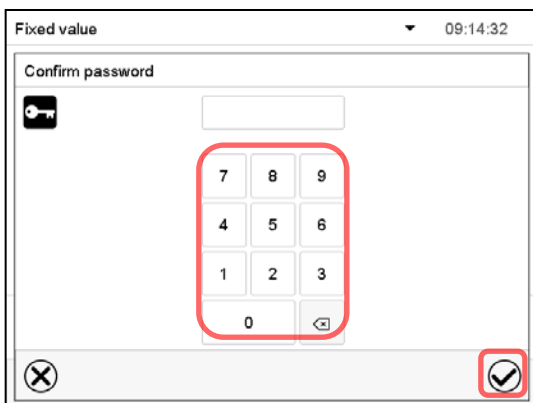

Repeat the password entry for confirmation (sample picture). For each character of the password, the required keyboard appears automatically.

Then press the **Confirm** icon.

13.5.2 Deleting the password for an individual authorization level

A user logged-in with “Service” or “Admin” authorization can delete the passwords of his current level and of the next lower level(s). To do this no password is entered during a password change.

Path: *Main menu > User > Password*

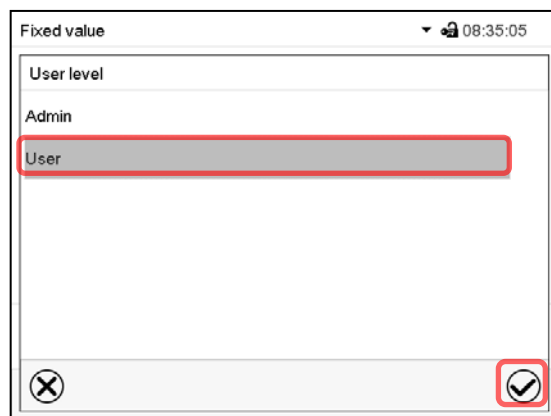
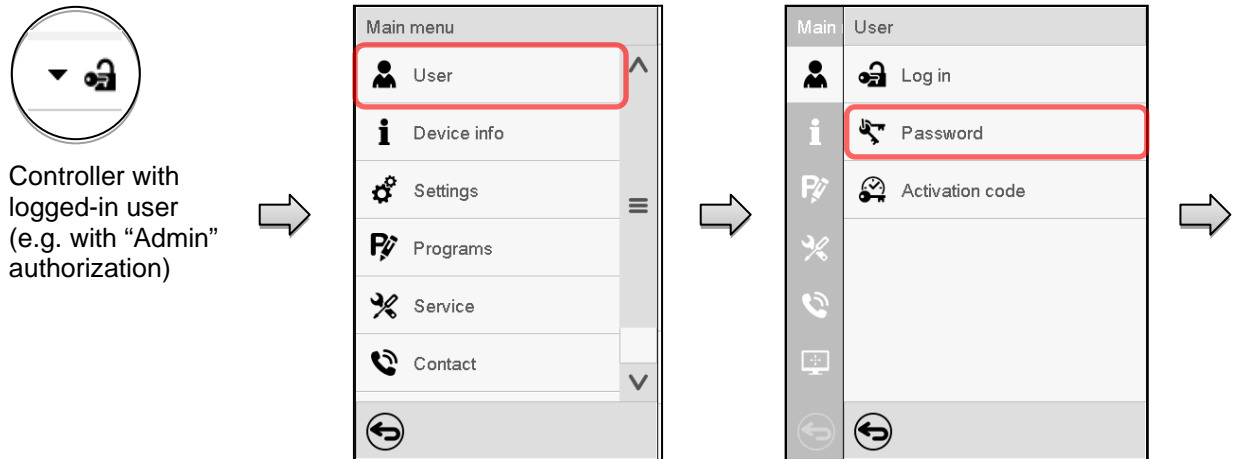

Select the authorization level for which the password shall be deleted.

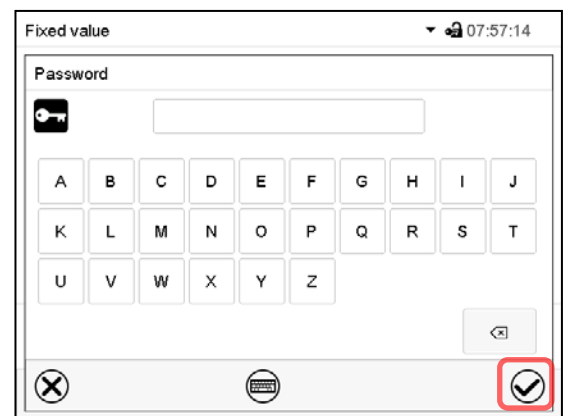

Do NOT enter anything in the “Password” screen. Press the **Confirm** icon.

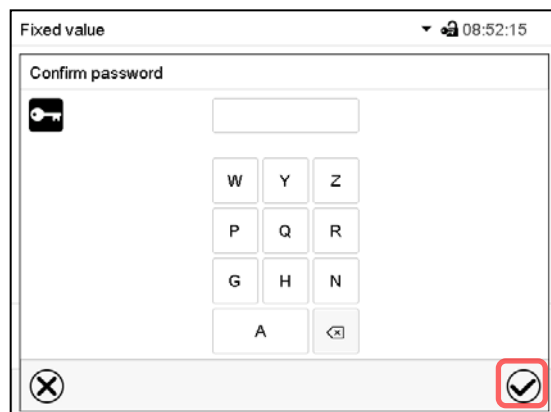

Do NOT enter anything in the “Confirm password” screen. Press the **Confirm** icon.

The password is deleted.

13.5.3 New password assignment for “service” or “admin” authorization level when the password function was deactivated

If the password protection for an authorization level has been deactivated, i.e., no password is assigned, no login for this level is possible. Therefore access to this authorization level is available without login.

If the password for the “Service” or “Admin” authorization has been deleted (chap. 13.5.2), a new password can be assigned for the current level and the next lower level(s) without user login.

Example: The password for the “Admin” authorization level was deleted, therefore every user without login has full access to the functions of the “Admin” authorization level. If access to this level shall become password protected again, the user can assign a new password for the “Admin” authorization level with the “Password” function.

Path: *Main menu > User > Password*

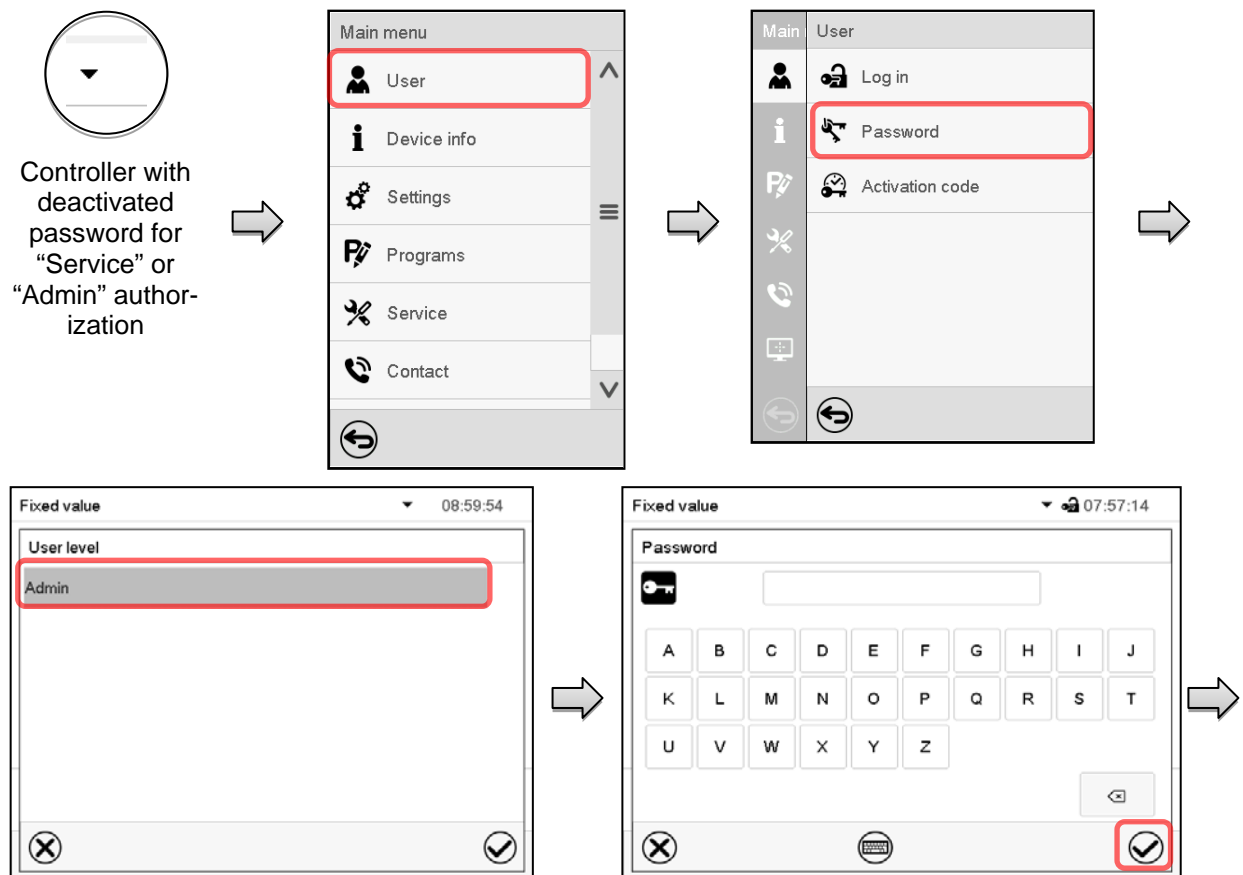

Select the authorization level, for which you want to assign a password.
(Example: “Admin” authorization)

Enter the desired password. If desired, press the **Change keyboard** icon to access other entry windows.

To confirm the entry, press the **Confirm** icon.

Repeat the password entry for confirmation. For each character of the password, the required keyboard appears automatically. Then press the **Confirm** icon.

13.6 Activation code

Certain functions of the controller can be unlocked with a previously generated activation code.

The activation code enables access to functions available only in the “Service” authorization level by users without a “Service” authorization. Such functions include e.g., adjustment or extended configurations.

The activation code is available in authorization levels.

Path: [Main menu](#) > [User](#) > [Activation code](#)

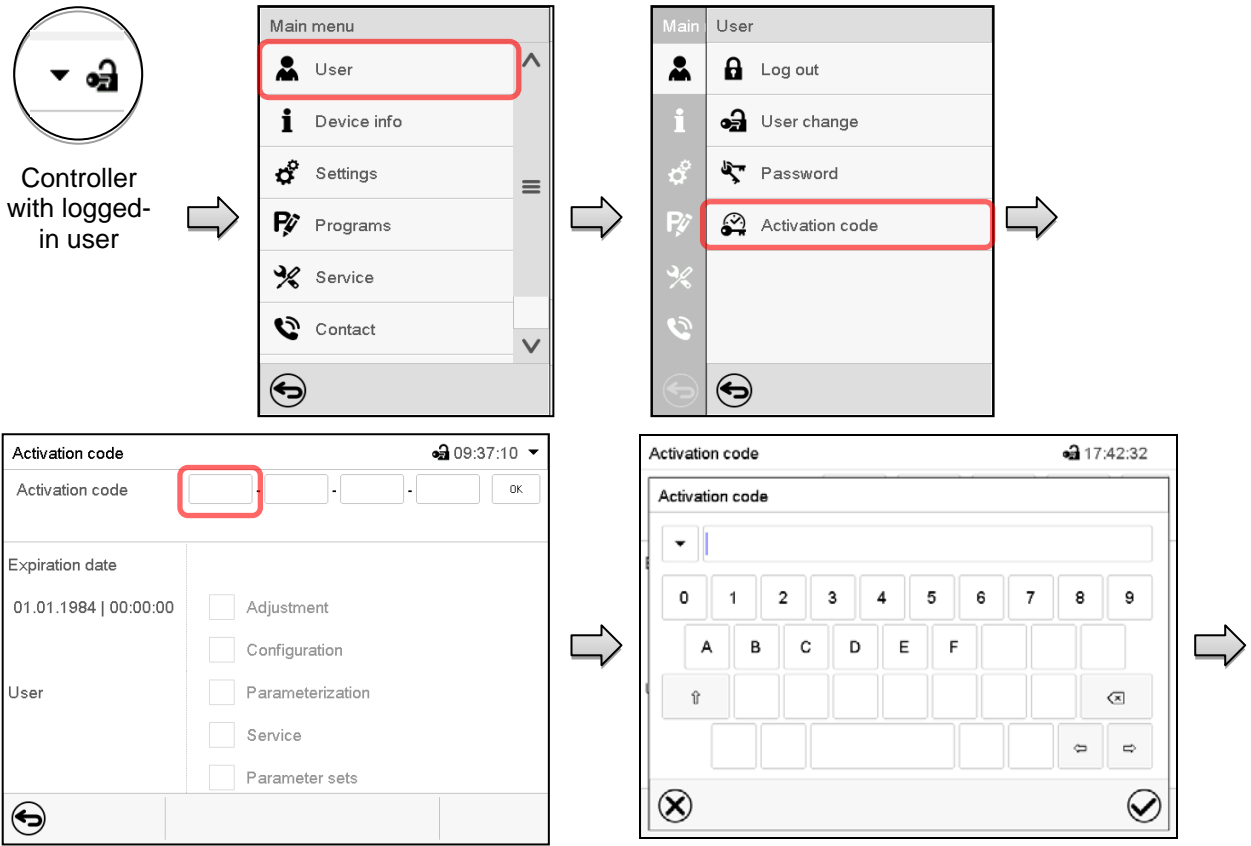

Activation code menu.

Select the first of the four entry fields.

Activation code entry window.

Enter the first four characters of the activation code and press the **Confirm** icon.

Select the next of the four entry fields and proceed accordingly until the entire code has been entered.

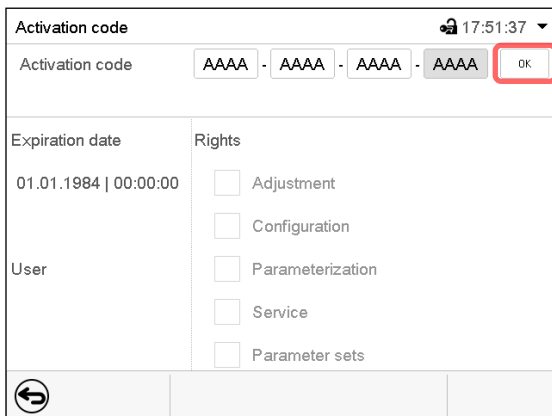

“Activation code” menu with entered code (sample view).

Press **OK** to take over the entry

The available functions are indicated by marked checkboxes.

Example: Extended configurations available.

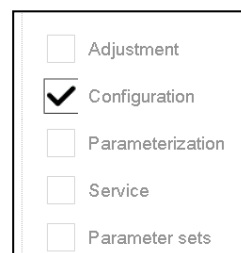

Under “Expiration date” the date of expiry of the code is displayed.

14. General controller settings

Most of the general settings can be accessed in the “Settings” submenu, which is available for users with “Service” or “Admin” authorization level. It serves to enter date and time, select the language for the controller menus and the desired temperature unit and to configure the controller’s communication functions.

14.1 Selecting the controller’s menu language

The MB2 program controller communicates by a menu guide using real words in German, English, French, Spanish, and Italian.

Path: [Main menu](#) > [Settings](#) > [Chamber](#)

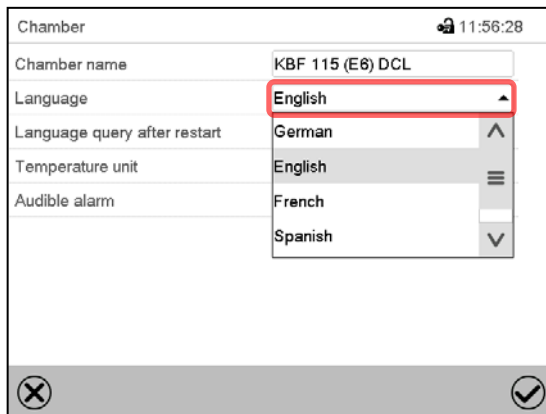

“Chamber” submenu.

Select the desired language.

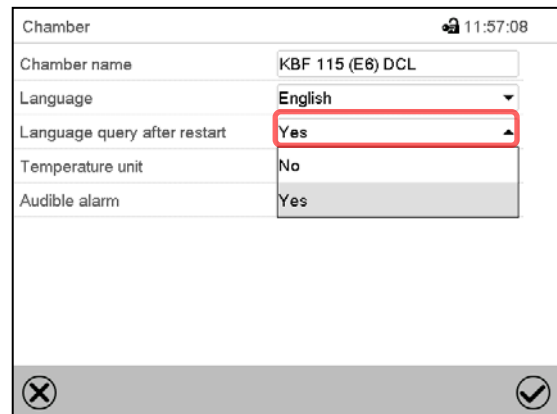

“Chamber” submenu.

Select if there shall be a language query after restarting the cabinet and press the **Confirm** icon.

14.2 Selecting the temperature unit

Following start-up of the cabinet:

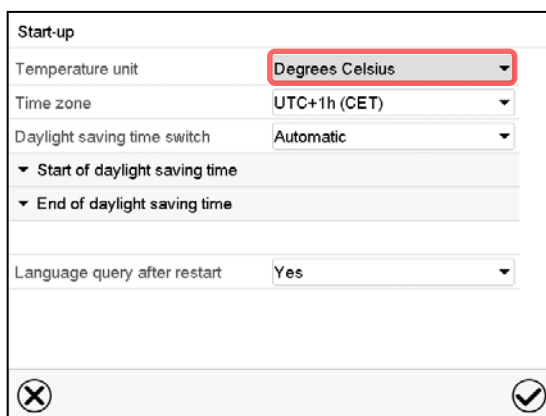

Or later:

Path: [Main menu](#) > [Settings](#) > [Chamber](#)

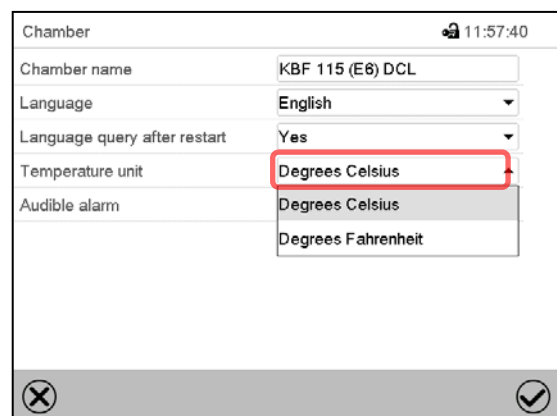

Select the desired temperature unit and press the **Confirm** icon.

Change of the temperature unit between °C and °F.

If the unit is changed, all values are converted accordingly

	C = degree Celsius	0 °C = 31°F	Conversion: [value in °F] = [value in °C] * 1,8 + 32
	F = degree Fahrenheit	100 °C = 212°F	

14.3 Setting date and time

Following start-up of the cabinet after language selection:

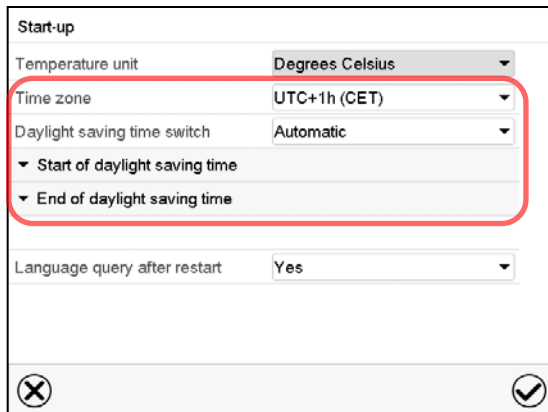

Select the time zone and configure the daylight saving time switch.

Or later:

Path: [Main menu](#) > [Settings](#) > [Date and time](#)

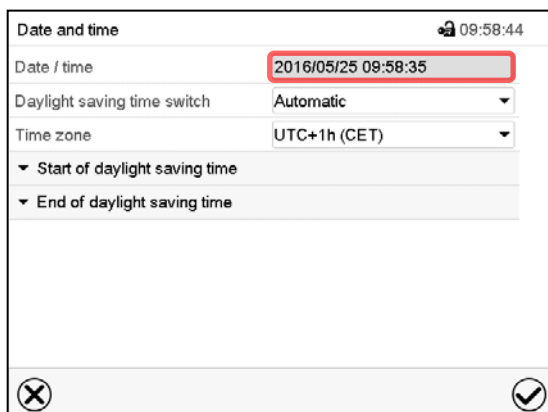

“Date and time” submenu.
Select the field “Date / time”.

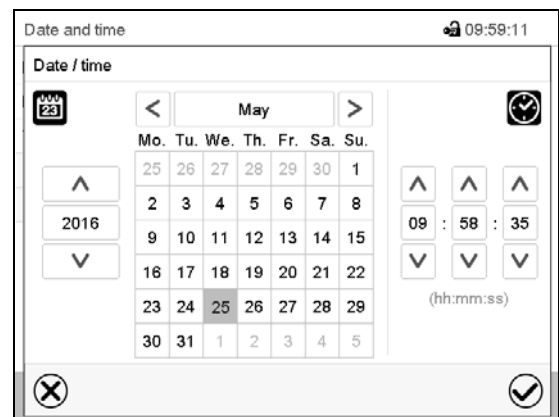

“Date / time” entry menu.
Enter date and time and press the **Confirm** icon.

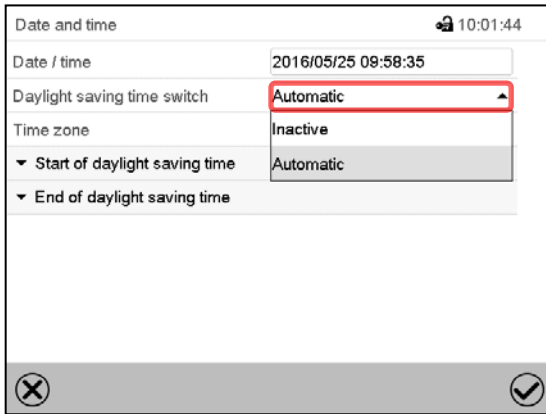

“Date and time” submenu.

In the field “Daylight saving time switch” select the desired setting “Automatic” or “Inactive”.

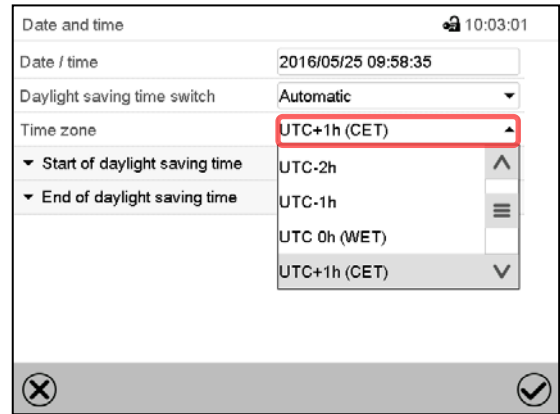

“Date and time” submenu.

Select the desired time zone and press the **Confirm** icon.

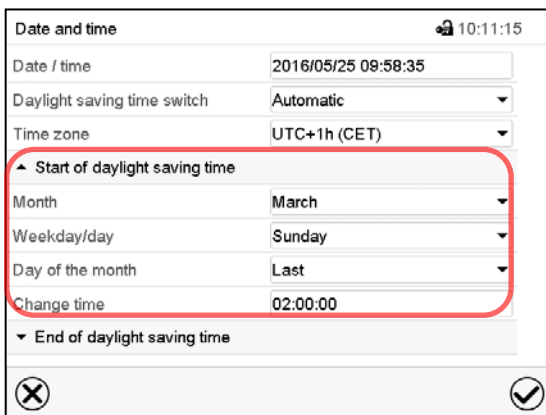

“Date and time” submenu. Select the desired start of the daylight saving time.

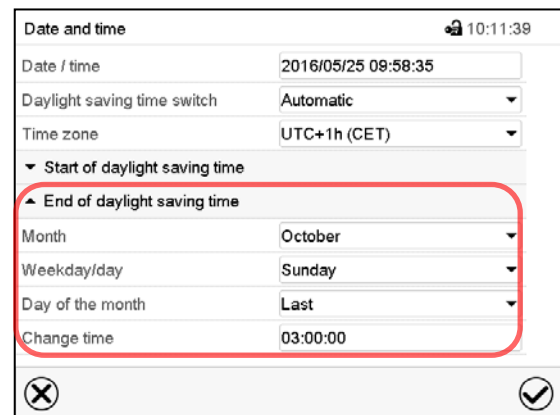

“Date and time” submenu. Select the desired end of the daylight saving time and press the **Confirm** icon.

After completing the settings, press the **Confirm** icon to take over the entries and exit the menu, **or** press the **Close** icon to exit the menu without taking over the entries.

14.4 Display configuration

14.4.1 Adapting the display parameters

This function serves to configure parameters like display brightness and operating times.

Path: [Main menu](#) > [Settings](#) > [Display](#) > [Display](#)

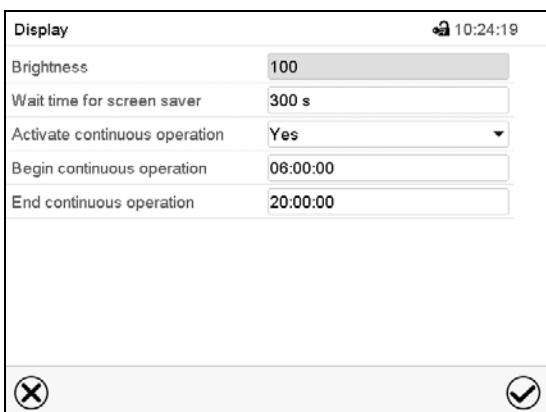

“Display” submenu.

- Select the field “Brightness”.
Move the grey slide to the left or right to define the brightness of the display
 - left = darker (minimum value: 0)
 - right = brighter (maximum value: 100)
 Press the **Confirm** icon.



- Select the field “Wait time for screen saver” and enter the desired waiting time for the screen saver in seconds. Setting range: 10 sec up to 32767 sec. During the waiting time the display is off. Confirm entry with **Confirm** icon.
- In the field “Activate continuous operation” select the desired setting “Yes” or “No”.

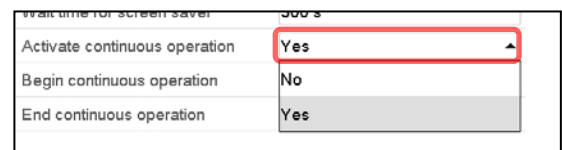

- Select the field “Begin continuous operation” (possible only if continuous operation is activated) and enter the time with the arrow keys. Confirm entry with Confirm icon.
- Select the field “End continuous operation. (only possible if continuous operation is activated) and enter the time with the arrow keys. Confirm entry with **Confirm** icon.

After completing the settings, press the **Confirm** icon to take over the entries and exit the menu, **or** press the **Close** icon to exit the menu without taking over the entries.

14.4.2 Touchscreen calibration

This function serves to optimize the display for the user’s individual angular perspective.

Path: [Main menu > Calibrate touchscreen](#)

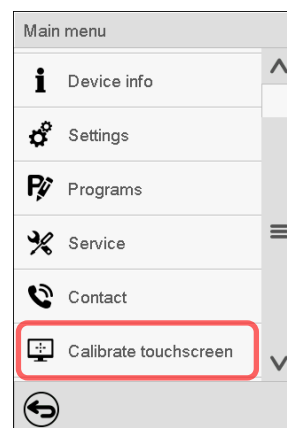
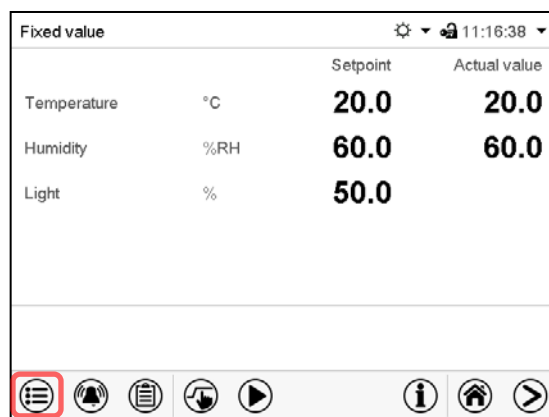

Normal display (example: cabinet with lights)

Select “Calibrate touchscreen” and follow the instructions on the display.

You need to touch all four corners of the touchscreen to calibrate it. Appropriate boxes appear successively in each corner.

	The clock icon shows how much time there is left to touch the currently activated box. If the box is not touched within this period, calibration is aborted and the display changes to Normal display.
--	--

After completing the calibration, i.e., touching all four boxes, the display changes to Normal display.

14.5 Network and communication

For these settings at least the “Admin” authorization level is required.

14.5.1 Ethernet

14.5.1.1 Configuration

Path: [Main menu](#) > [Settings](#) > [Ethernet](#)

“Ethernet” submenu.

- In the field “IP address assignment” select the desired setting “Automatic (DHCP)” or “Manual”.

With selection “Manual” you can enter the IP-address, the subnet mask and the standard gateway manually.

- Select “DNS device name” and enter the DNS device name. Confirm entry with **Confirm** icon.
- In the field “DNS server address” select the desired setting “Automatic” or “Manual”.

With selection „Manual“ you can enter the DNS server address manually.

After completing the settings, press the **Confirm** icon to take over the entries and exit the menu, **or** press the **Close** icon to exit the menu without taking over the entries.

14.5.1.2 Display of MAC address

Path: [Main menu](#) > [Device info](#) > [Ethernet](#)

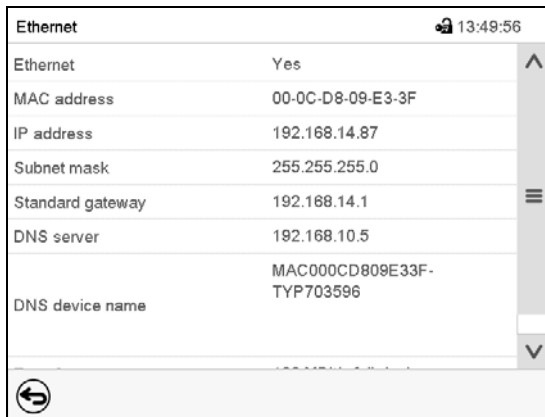

Ethernet		🔒 13:49:56
Ethernet	Yes	^
MAC address	00-0C-D8-09-E3-3F	
IP address	192.168.14.87	
Subnet mask	255.255.255.0	
Standard gateway	192.168.14.1	☰
DNS server	192.168.10.5	
DNS device name	MAC000CD809E33F-TYP703596	

“Ethernet” submenu (example).

14.5.2 Web server

This controller menu serves to configure the web server. Then you can enter the cabinet’s IP-address in the Internet. The IP address is available via [Chamber information](#) > [Ethernet](#). The web server opens. Enter the user name and password which have been assigned for the web server in the controller menu. This enables online access to the controller display, to see e.g., the event list or error messages. In this view no settings can be changed.

Path: [Main menu](#) > [Settings](#) > [Web server](#)

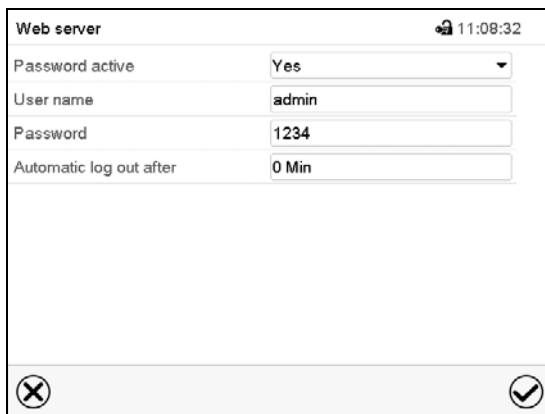

Web server		🔒 11:08:32
Password active	Yes	▼
User name	admin	
Password	1234	
Automatic log out after	0 Min	

“Webserver” submenu.

- In the field “Password active” select the desired setting “Yes” or “No”.

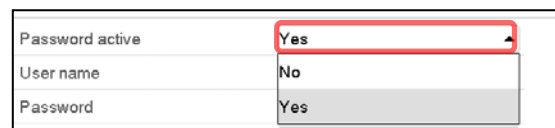

Password active	Yes
User name	No
Password	Yes

- Select the field “User name” and enter the desired user name. Confirm entry with **Confirm** icon.
- Select the field “Password” and enter the desired password. Confirm entry with the **Confirm** icon.
- Select the field “Automatic log out after” and enter the time in minutes after which the webserver shall log out automatically. Setting range: 0 min to 65535 min. Confirm entry with **Confirm** icon.

After completing the settings, press the **Confirm** icon to take over the entries and exit the menu, **or** press the **Close** icon to exit the menu without taking over the entries.

14.5.3 E-Mail

As soon as an alarm was triggered, an e-mail is sent to the configured e-mail address.

Path: [Main menu](#) > [Settings](#) > [Email](#)

E-mail address entry:

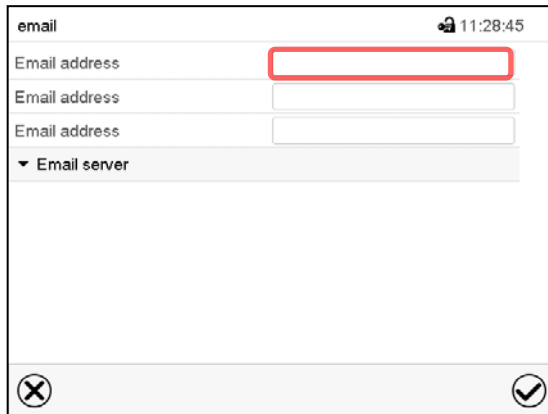

“Email” submenu.

Select the desired e-mail address field and enter the e-mail address. You can use the **Keyboard change** icon for entry. Confirm entry with **Confirm** icon.

E-mail server settings:

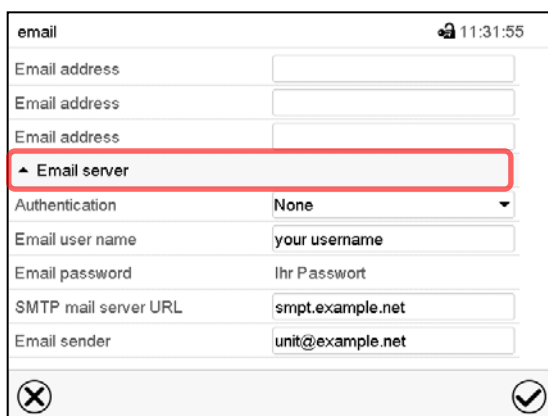

“Email” submenu.

Select the field “Email server” to access the settings

- In the field “Authentication” select the desired setting “None” or “SMTP” auth“.

With the setting “SMTP auth”, you can enter a password under “Email password”.

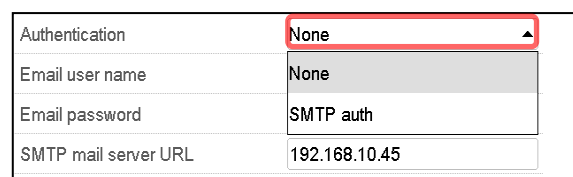

- Select the field “Email user name” and enter the desired user name. Confirm entry with **Confirm** icon.
- Select the field “SMTP mail server URL” and enter the SMPT mail server URL. Confirm entry with **Confirm** icon.
- Select the field “Email sender” and enter the desired Email sender. Confirm entry with **Confirm** icon.

After completing the settings, press the **Confirm** icon to take over the entries and exit the menu, **or** press the **Close** icon to exit the menu without taking over the entries.

14.6 USB menu

When you insert a USB-stick, the “USB” menu opens.

Depending on the user’s authorization level, different functions (highlighted in black) are available for the logged-in user.

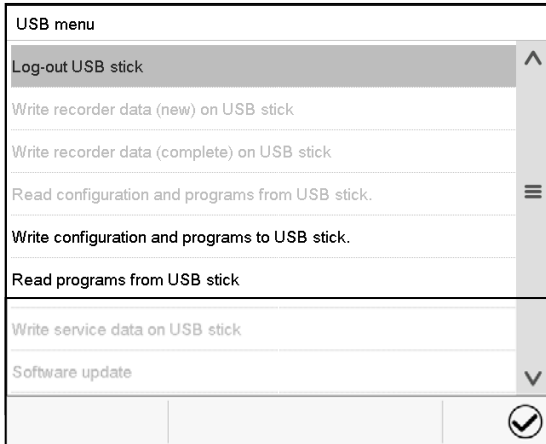

Available functions with “User” authorization level

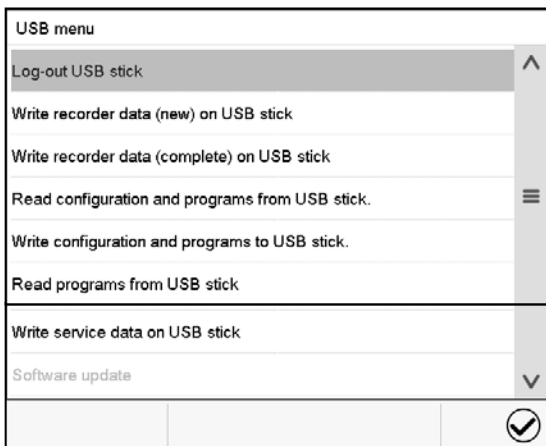

Available functions with “Admin” authorization level

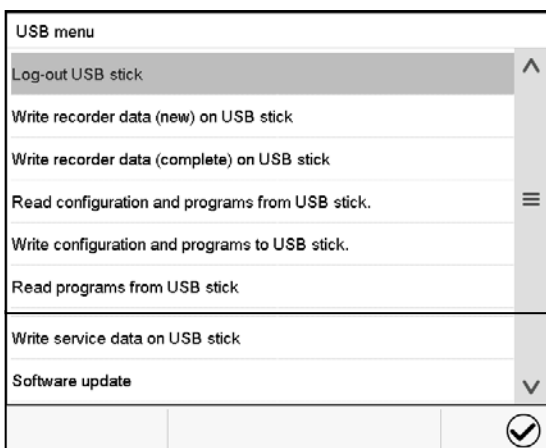

Available functions with “Service” authorization level

15. General information

15.1 Service contact page

Path: [Main menu](#) > [Contact](#)

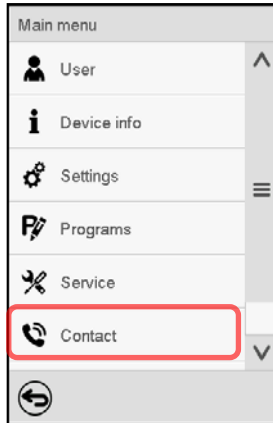

15.2 Current operating parameters

 Press the **Information** icon to access the “Info” menu from Normal display.

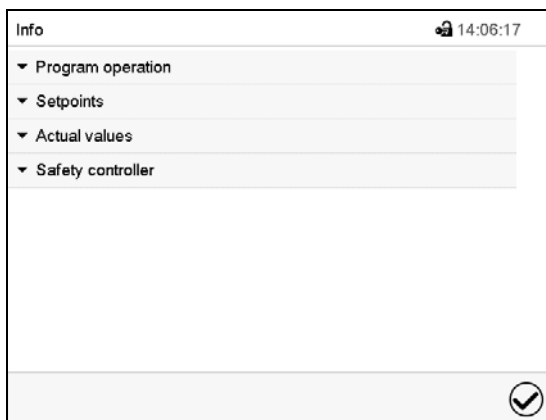

“Info” menu.

Select the desired information.

- Select “Program operation” to see information on a currently running program.

▲ Program operation		▲
Program type	Time program	
Program name	program 1	
	Programmhinweis	☰
Program info		
Program start	08.06.2016 07:34:57	
Program duration	87:00:00	
Rem. program runtime	87:00:00	▼
Program end	11.06.2016 22:35:49	
Section number	1 / 87	
Section duration	00:00:00	
Remaining section time	01:00:00	☰

- Select “Setpoints” to see information on the entered setpoints and operation lines.

▲ Setpoints	
Temperature	40.0 °C
Humidity	80.0 %rH
Fan	100.0 %
Operation lines	0000000000000000

(cabinet without lights)

▲ Setpoints	
Temperature	50.0 °C
Humidity	68.7 %RH
Fan	100.0 %
Light	97.8 %
Functions on/off	0000000000000000

(cabinet with lights)

- Select “Actual values” to see information on the current actual values.
- Select “Safety controller” to see information on the safety controller status.



▲ Actual values	
Temperature	40.0 °C
Humidity	80.0 %

▲ Safety controller	
Switch value	40.0 °C
Actual value	20.3 °C
Status	Not triggered

15.3 Event list

The “Event list” displays status information and errors of the current day. It enables to view the last 100 events or defective conditions of the chamber.

 Press the **Event list** icon to access the event list from Normal display.

Event list			🔒 13:18:52
2016/06/07	09:09:53	Login Service (Touch)	▲
2016/06/07	09:09:53	Automatic log out Admin	
2016/06/07	07:47:25	Login Admin (Touch)	
2016/06/07	07:46:15	Automatic log out Admin	
	2016/06/07	07:46:15	Power on
	2016/06/06	16:08:09	Power off
2016/06/06	10:50:25	Login Admin (Touch)	
2016/06/06	10:49:44	Automatic log out Admin	
	2016/06/06	10:49:44	Power on

Event list

 Press the **Update** icon to update the event list.

 **Attention:** Following a modification of the language setting (chap. 14.1) or the storage interval of the chart recorder (chap. 16.2) the Event list is cleared.

15.4 Counter of operating hours (cabinet with lights)

Path: [Main menu > Service > Counter](#)

There are two counters: one for the cabinet operating hours and the other for the operating hours of the illumination.

Counter 🔒 11:34:43		
Description	Output	Limit value
Chamber op. hours	0	0
Light op. hours	0	0
...	0	0
...	0	0
...	0	0
...	0	0
...	0	0
...	0	0
...	0	0

Both counters can be reset independently. The reset menu is available only for users with “Service” authorization. To have the values reset, please contact your local Datacolor service representative.

15.5 Technical information on the cabinet

Path: [Main menu > Device info](#)

<table border="1"> <tr> <td>Main</td> <td>Device info</td> </tr> <tr> <td></td> <td>i General</td> </tr> <tr> <td>i</td> <td>v1.x Versions</td> </tr> <tr> <td></td> <td> In-/Outputs</td> </tr> <tr> <td></td> <td> Modbus inputs</td> </tr> <tr> <td></td> <td> Ethernet</td> </tr> <tr> <td></td> <td></td> </tr> <tr> <td></td> <td></td> </tr> </table>	Main	Device info		i General	i	v1.x Versions		In-/Outputs		Modbus inputs		Ethernet						
	Main	Device info																
		i General																
	i	v1.x Versions																
		In-/Outputs																
		Modbus inputs																
		Ethernet																
	Cabinet name and setup																	
	Versions of CPU, I/O module and safety controller	for Datacolor service																
	Information on digital and analog inputs and outputs and phase angle outputs	for Datacolor service																
	Information on modbus analog and digital inputs	for Datacolor service																
	Information on Ethernet connection, MAC address display	chap. 14.5.1																
	Back to main menu																	



16. Chart recorder display

This view offers graphic representation of the measurement course. Data representation imitates a chart recorder and allows recalling any set of measured data at any point of time taken from the recorded period.

16.1 Views

	Press the Change view icon to access the pen recorder display.
---	---

16.1.1 Show and hide legend

	Show legend		Hide legend
---	--------------------	---	--------------------

Press the **Show legend** icon to display the legend on the right side of the display.

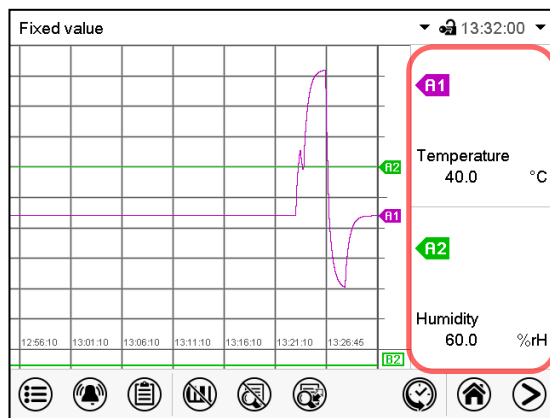

Display with cabinet without lights

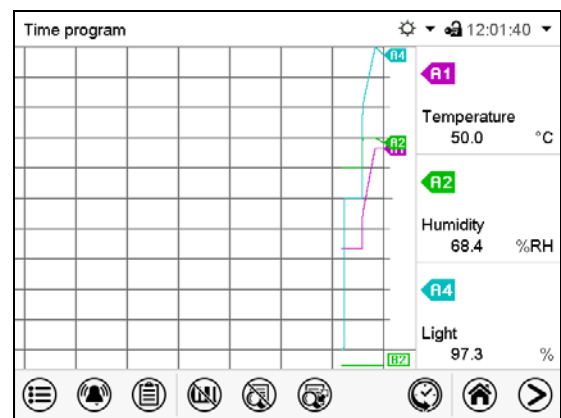

Display with cabinet with lights

16.1.2 Switch between legend pages

	Switch legend
---	----------------------

Press the **Switch legend** icon to switch between the legend pages

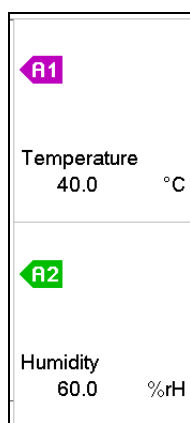

1st page, cabinet without lights

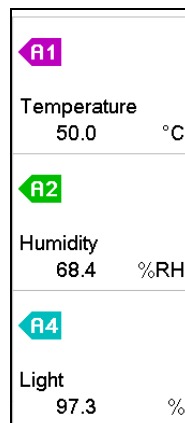

1st page, cabinet without lights

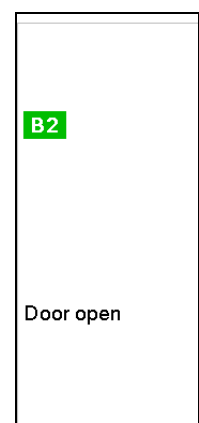

2nd page

16.1.3 Show and hide specific indications

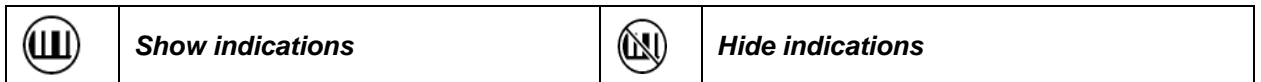

Press the **Show indications** icon to display the indication “Door open” (B2).

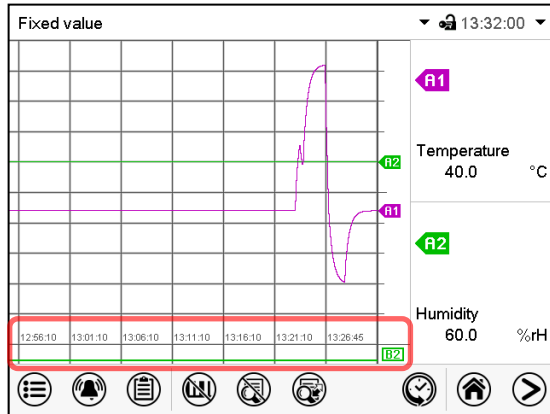

Display with cabinet without lights

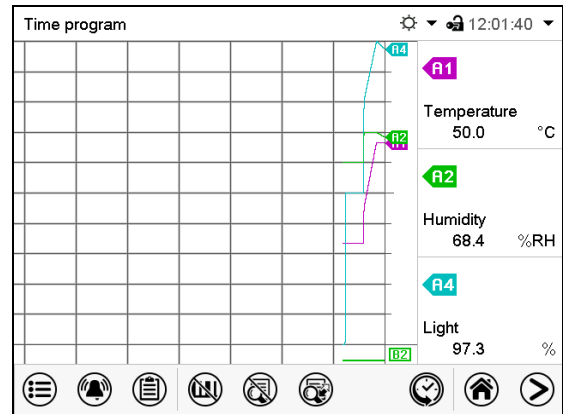

Display with cabinet with lights

16.1.4 History display

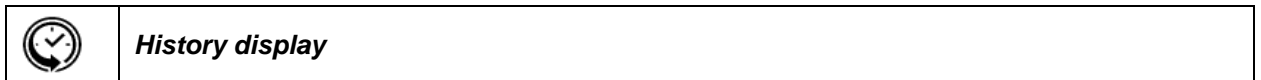

Press the **History display** icon to change to the history display.

The chart recorder is paused. Data recording continues in the background.

Move the central red line by tapping and holding to the desired position.

The legend at the right side shows the values of the current line position.

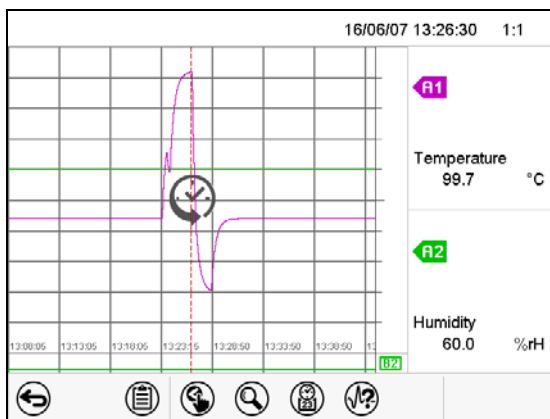

History display with cabinet without lights

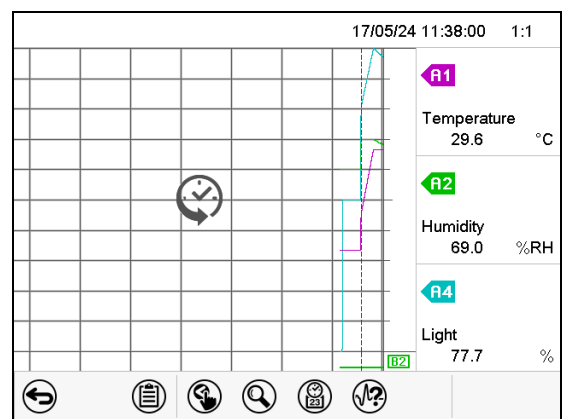

History display with cabinet with lights

Then further icons appear:

History display: Curve selection



Press the **Curve selection** icon to access the “Curve selection” submenu.

Select the curves to be displayed by checking the checkbox of the corresponding parameter. Press the **Confirm** icon.

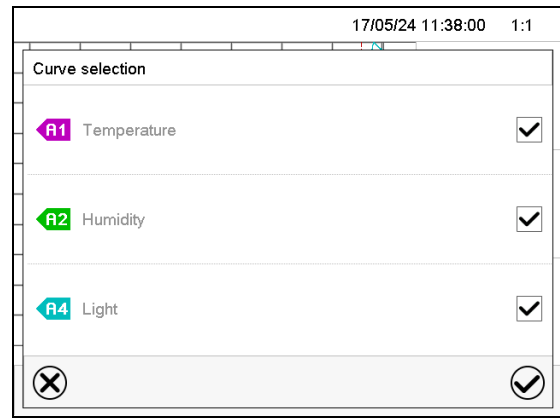
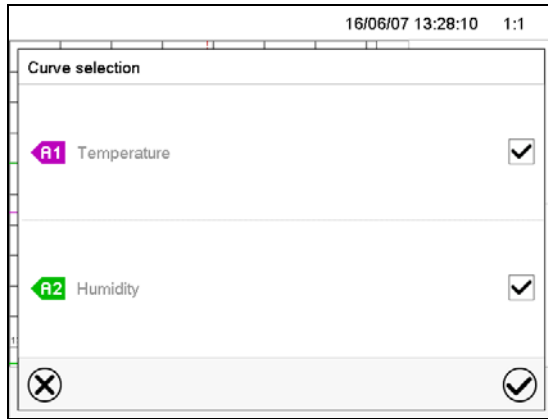

“Curve selection” submenu (cabinet without lights)

“Curve selection” submenu (cabinet with lights)

History display: Search the required instant

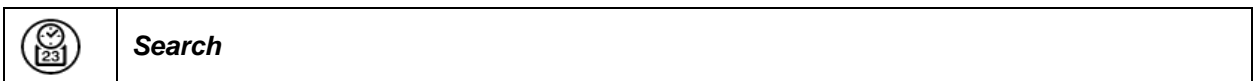

Press the **Search** icon to access the “Search” submenu.

Select the required instant by entering its date and time and press the **Confirm** icon

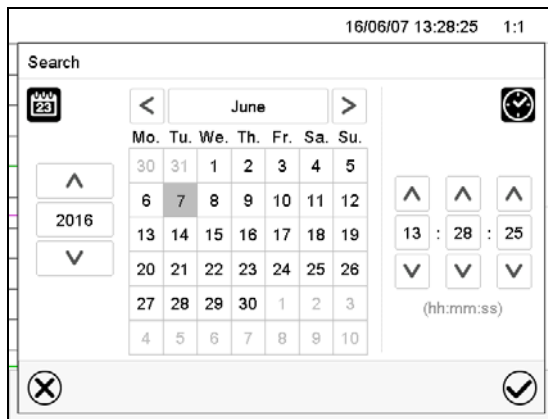

“Search” submenu.

History display: Zoom function



Press the **Zoom** icon to access the “Zoom” submenu. Select the zoom factor and press the **Confirm** icon

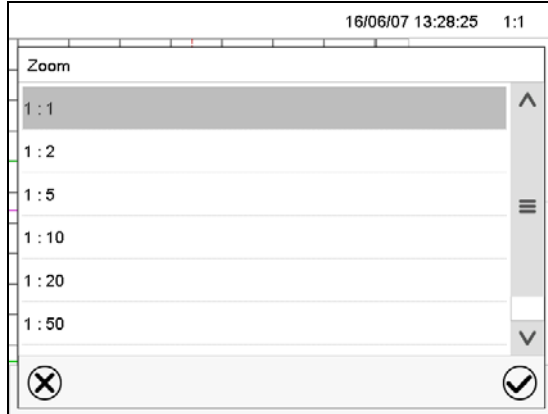

“Zoom” submenu.

History display: Show and hide arrow keys to scroll to an instant



Press the **Show scroll buttons** icon to access the “Page selection” submenu.

Scroll buttons are shown on the left and on the right. Use them to move along the timeline.

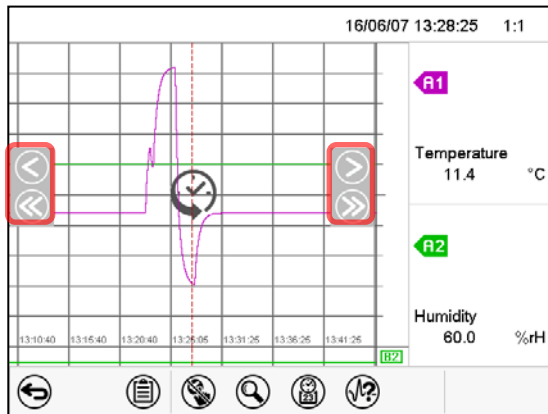

“Page selection” submenu (cabinet without lights)

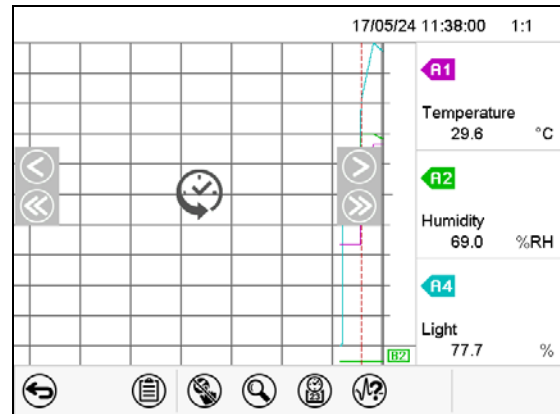

“Page selection” submenu (cabinet with lights)

16.2 Setting the parameters

This menu allows setting the storage interval, the type of values to be shown and the scaling of the temperature and humidity charts.

Path: [Main menu](#) > [Settings](#) > [Measurement chart](#)

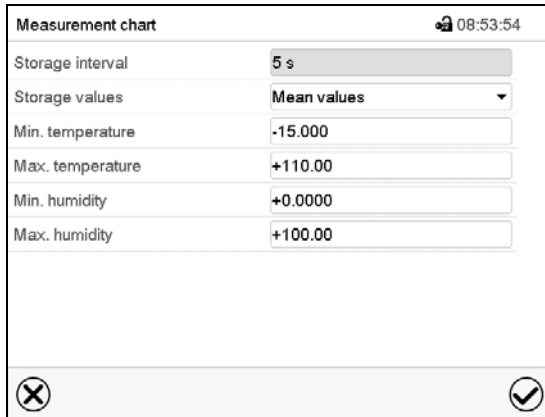

Measurement chart		08:53:54
Storage interval	5 s	
Storage values	Mean values	
Min. temperature	-15.000	
Max. temperature	+110.00	
Min. humidity	+0.0000	
Max. humidity	+100.00	

“Measurement chart” submenu.

- Select the field “Storage interval” and enter the desired storage interval. Confirm entry with **Confirm** icon.

The available presentation depends on the pre-selected storage rate. Factory setting: 60 seconds. This means the higher the storage rate, the more precisely but shorter the data representation will be.

- In the field “Storage values” select the desired value type to be displayed.

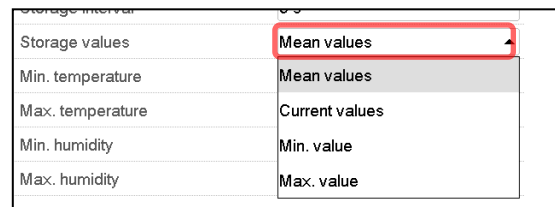

Storage interval	60 s
Storage values	Mean values
Min. temperature	Mean values
Max. temperature	Current values
Min. humidity	Min. value
Max. humidity	Max. value

- For scaling the representation select the desired minimum and maximum temperature or humidity value and enter the desired value. Temperature display range: -20 °C up to 110 °C. Humidity display range: 0% r.H. up to 100% r.H. Confirm entry with **Confirm** icon.

CAUTION	
	<p>Setting the storage rate or rescaling (minimum and/or maximum) will clear the measured-value memory and the event list.</p>
	<p>Danger of information loss.</p>
	<p>➤ Change the storage rate or scaling ONLY if the previously registered data is no longer needed.</p>

After completing the settings, press the **Confirm** icon to take over the entries and exit the menu, **or** press the **Close** icon to exit the menu without taking over the entries.

17. Humidification / dehumidification system

The cabinet is equipped with a capacitive humidity sensor. This results in a control accuracy of up to +/- 3 % r.H. of the set point.

Temperature and humidity control were optimized to a working point 21 °C / 69.8 °F and 65% r.H.

The temperature-humidity diagrams below show the possible working ranges for humidity.

- In the “setpoints” menu you can turn humidity control (humidification and dehumidification) on or off with the setting “Control on/off” (chap. 6.3).

With humidity control turned off, the humidification module cools down. After activation it will take up to 20 minutes until the humidification function is fully available again. This setting is required when operating the cabinet without a water connection in order to avoid humidity alarms.

- Operation line “Humidity off” serves to turn off the humidification / dehumidification system in Fixed value operation (chap. 7.3, time program operation (chap. 9.7.3) and week program operation (chap. 10.6.5). This allows configuring the disconnection for individual program sections.

When the humidification / dehumidification system is turned off via operation line it remain on standby (filled and heated). Therefore it is immediately available after turning on.



The preset temperature and humidity values should be situated within the optimum range (hatched range in the diagram below). Only within this area will the cabinet not be exposed to excessive moisture due to condensation.

In the short-term set points outside the optimum range can also be targeted. The control accuracies of +/- 3 % r.H., however, cannot be guaranteed in this case.

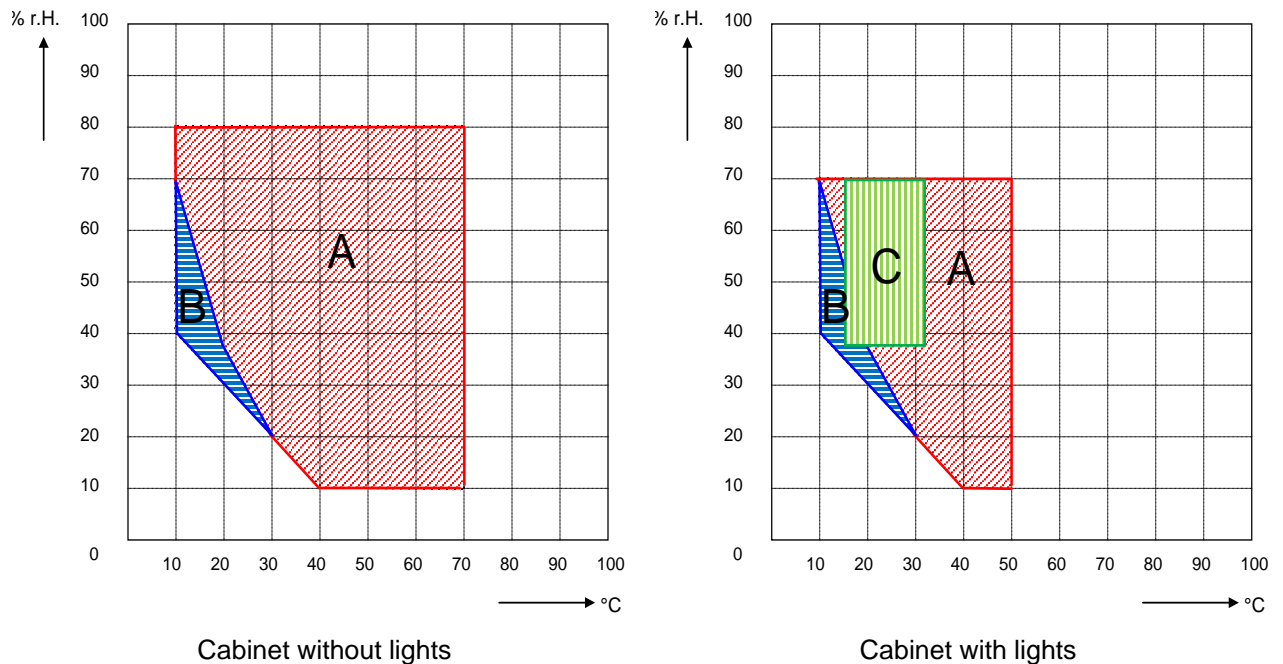

Figure 20: Temperature-humidity diagram

- Range A: Control range of temperature and relative humidity, condensation free range
- Range B: Discontinuous range (no continuous operation, up to 24 h)
- Range C: Optimized operating range from 15 °C to 31 °C and 38 % r.h. to 70% r.h. with stable operation of the humidity system.

Remarks on cabinet with lights:

Turning on the illumination modifies the operating range, and the humidity set-point at 20°C must not be lower than 30 % RH, otherwise stable humidity control is not guaranteed

Outside the optimized operating range there is increased risk of condensation, which can trigger the internal residual current operated device if the illumination is switched on and thus cause switching off the unit. The residual current operated device permanently switches off-tension the unit as soon as the residual current exceeds 30 mA.

Due to the construction of the cabinet with light, no icing occurs in the inner chamber during the de-humidification. The cabinet can be operated permanently without manual defrosting.



Heat emission of electrical devices connected inside the cabinet may modify the temperature and humidity range.

The cabinets are equipped with a door heating system to prevent condensation in the door area.

If the set points for temperature or humidity are outside the optimum range, condensation can arise in the door area.

	CAUTION
	<p>Condensation by excess humidity.</p> <p>Danger of corrosion on the housing after operating at humidity values > 70 % r.H. for a long period.</p> <ul style="list-style-type: none"> ➤ Dry the appliance completely before shut-down: <ul style="list-style-type: none"> • Set the humidity to 0 % r.H. The humidity system must be activated. • Set the temperature set point to 60 °C / 140 °F for approx. 2 hours (Manual mode). • Only then, shut down the cabinet at the main power switch (1) and close the water supply tap.



Having turned off the cabinet by the main power switch (1), always close the water supply tap.

If you operate the cabinet at high humidity and then immediately turn off the cabinet, the internal wastewater collector may overflow due to the condensate. This may lead to the emergence of water at the cabinet.

	CAUTION
	<p>Overflow of the internal wastewater tank due to condensate.</p> <p>Emergence of water at the cabinet.</p> <ul style="list-style-type: none"> Ø Following high humidity operation, do NOT directly turn off the cabinet. ➤ Pump off the condensate before shut-down: <ul style="list-style-type: none"> • Set the humidity to 0 % r.H. The humidity system must be activated. Operate the cabinet for at least 2 hours. • Only then, shut down the cabinet at the main power switch (1) and close the water supply tap.

17.1 Function of the humidifying and dehumidifying system

Humidifying system

The humidifying and dehumidifying system is located in the humidity generation module. In a cylindrical container with a volume of about 2 liters an electrical resistance heating evaporates water. The water content is kept exactly at the boiling point, and thus steam can be immediately generated in sufficient quantity for rapid humidity increases or for compensation of humidity losses, e.g. by door openings. Condensation forming on the outer walls of the useable volume is led through a water drain in the outer chamber into the wastewater can which is pumped off automatically to the wastewater pipe when required.

Freshwater

You can supply the cabinet with freshwater via a water pipe or by manually filling a freshwater can (option, chap. 4.5). You can mount the can on the rear of the cabinet or place it next to the cabinet.

	<p>In order to ensure accurate humidifying, observe the following points with regard to the freshwater supply:</p> <ul style="list-style-type: none"> • Supply pressure 1 to 10 bar when connecting to a water pipe • Water type: deionized (demineralized) water • To ensure humidification during 24 hours even at high humidity set-points with manual water supply, we recommend filling the freshwater can (option) at the end of each day. • Water intake temperature NOT below +5 °C / 41 °F and not exceeding 40 °C / 104 °F.
---	--

	<p>The manufacturer is NOT responsible for the water quality provided by the customer.</p> <p>Any problems and malfunctions that might arise following use of water of deviating quality is excluded from liability by the manufacturer.</p>
---	--

Automatic fresh water supply via water pipe

With this type of supply, the humidity system is continuously functional.

Manual fresh water supply via freshwater can (option, chap. 4.5)

With this type of supply, the humidity system is functional only if the water can is sufficiently filled. Check the filling level daily. The water reserve in the can is sufficient for a period, which may last between one and several days, depending on the humidity demand (entered humidity set-point and number of door openings).

Waste water

The condensation water from the interior is collected in an internal can with a volume of approx. 0.5 liters. It is pumped off via the waste water pipe.

Dehumidifying system

When the humidity system is activated, the cabinet dehumidifies as needed in order to reach the entered humidity set-point inside the control range of temperature and relative humidity (Figure 20).

Dehumidification occurs in case of need by means of defined dew point undershoot of several evaporators of the refrigeration system. The condensate which forms is carried away as waste water.

If the humidity system is turned off while there are descending temperature curves, then operation of the refrigeration system may cause dehumidification of the charging material.

For error indications concerning water supply and humidity system, see chap. 11.1.3 and 22.

18. Defrosting at refrigerating operation (cabinet without lights)

The cabinets are very diffusion-proof. To ensure high temperature precision there is no automatic cyclic defrosting device. The DCT™ refrigerating system largely avoids icing of the evaporation plates. However, at very low temperatures the moisture in the air can condense on the evaporator plates leading to icing.

	Always close the door properly.
---	---------------------------------

Operation with temperature set-points > +5 °C / 41 °F at an ambient temperature of 25 °C / 77 °F:

The air defrosts the ice cover automatically. Defrosting is continually performed.

Operation with temperature set-points < +5 °C / 41 °F:

Icing on the evaporator is possible. Defrost the cabinet manually.

	<p>With temperature set-points < +5 °C / 41 °F, regularly defrost the cabinet manually:</p> <ul style="list-style-type: none"> • Set the humidity to 0 % r.H. The humidity system must be activated. • Set the temperature to 40 °C / 104 °F (Manual Mode). • Let the cabinet operate for about 30 minutes with the door closed.
---	--

	Too much ice on the evaporator is noticeable by reduced refrigerating performance.
---	--

When turning off the cabinet following prolonged refrigerating operation below +5 °C / 41 °F, there is danger of overflowing due to uncontrolled defrosting of icing on the evaporator.

	CAUTION
	<p>Uncontrolled defrosting of icing on the evaporator.</p> <p>Danger of overflowing.</p> <p>After several days of refrigerating operation below +5 °C / 41 °F:</p> <ul style="list-style-type: none"> ⊘ Do NOT directly turn off the cabinet. ➤ Manually defrost the cabinet (see description above). ➤ Then, shut down the cabinet at the main power switch (1) and close the tap of the water supply. Keep removed the access port plugs.

19. Illumination system (cabinet with lights)

The cabinet with lights unit is equipped with Narva BIO vital[®] fluorescent tubes installed in two light cassettes. They illuminate very homogeneously the racks below them. A special reflector material ensures optimum light diffusion and efficient utilization of the light intensity. The lens of the headlight leads to a homogeneous intensity distribution even with a short distance to the rack.

Both light cassettes are permanently connected. The cable length permits easily removal to replace the fluorescent tubes. Control is effected via the MB2 controller. Light intensity is off at 0% and is dimmable between 1% and 100% in 1% steps.

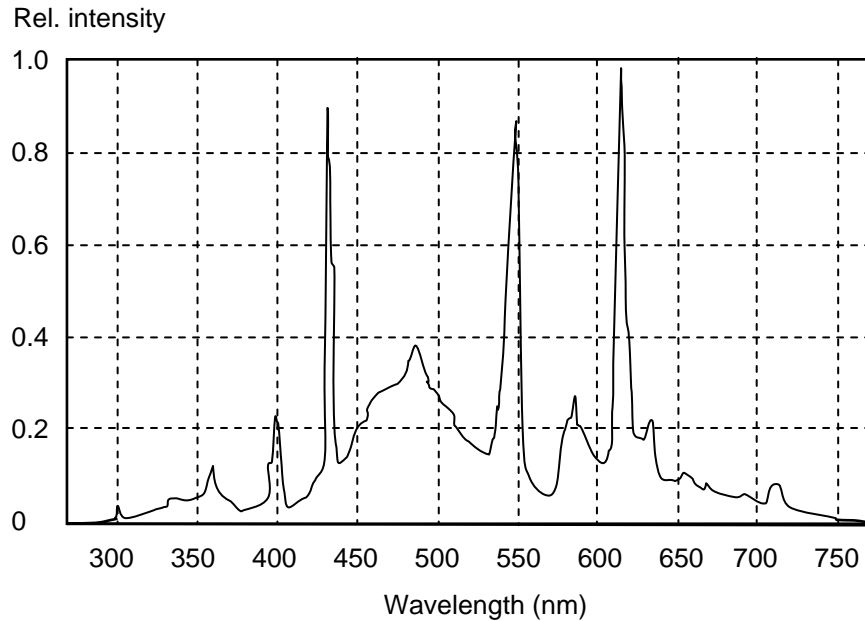



Figure 21: Spectrum

Narva BIO vital[®] presents a spectral composition which is almost equivalent to natural daylight. It includes the visible areas of the spectrum as well as an additional ultraviolet percentage (UV-A and UV-B) in a similar manner like sunlight.

Type of fluorescent tube: T8 fluorescent tube in form of a rod with a tube diameter of 26 mm / 1.02 in.
 Length: 438 mm / 17.2 in, 15W.



Illumination at 100% intensity: 4500 LUX (average value, measured with a spherical sensor (+/-10%) by 12 cm / 4.7 in below the light cassette)

The waste heat of the fluorescent tubes leads to a modification of the temperature - humidity diagram:

	<p>When operating the chamber with illumination: Restricted temperature and humidity range 20 °C / 68 °F to 60 °C / 140 °F.</p> <p>At ≤ 20 °C do not set the humidity set-point below 30 % r.H. Otherwise, no stable humidity control is guaranteed.</p>
---	---

20. Maintenance, cleaning, and service

20.1 Maintenance intervals, service

 	 DANGER
	<p>Electrical hazard. Danger of death.</p> <ul style="list-style-type: none"> Ø The cabinet must NOT become wet during operation or maintenance works. Ø Do not remove the rear panel of the cabinet. ➤ Before conducting maintenance work, turn off the cabinet at the main power switch and disconnect the power plug. ➤ General maintenance work must be conducted by licensed electricians or experts authorized by Datacolor. ➤ Maintenance work at the refrigeration system must only be conducted by qualified personnel who underwent training in accordance with EN 13313:2010 (e.g. a refrigeration technician with certified expert knowledge acc. to regulation 303/2008/EC). Follow the national statutory regulations.

Ensure regular maintenance work is performed at least once a year and that the legal requirements are met regarding the qualifications of service personnel, scope of testing and documentation. All work on the refrigeration system (repairs, inspections) must be documented.

	The warranty becomes void if maintenance work is conducted by non-authorized personnel.
---	---

Have conducted regular maintenance work on the steam humidifier at least once a year. The operating behavior and the maintenance intervals of the humidifier essentially depend on the available water quality and the amount of steam produced in the meantime.

	We recommend cleaning the condensers at least twice a year. A qualified technician must perform cleaning.
---	---

	Replace the door gasket only when cold. Otherwise, the door gasket may become damaged.
---	--

With an increased amount of dust in the ambient air, clean the condenser fan (by suction or blowing) several times a year.

Support Questions? If you need help with a Datacolor product, please contact one of our top-rated technical support teams located around the world for your convenience. You can find contact information below for the Datacolor office in your area.

Americas	+1.609.895.7465 +1.800.982.6496 (toll-free) +1.609.895.7404 (fax) NSASupport@datacolor.com
Europe	+41.44.835.3740 +41.44.835.3749 (fax) EMASupport@datacolor.com
Asia Pacific	+852.2420.8606 +852.2420.8320 (fax) ASPSupport@datacolor.com

Or contact your local representative. Datacolor has representatives in over 60 countries.

For a complete list, visit www.datacolor.com/locations.

20.2 Replacement of the fluorescent tubes

The average life expectancy of the fluorescent tubes is about 10,000 hours. We recommend replacing the tubes every year in order to ensure full light intensity.

To replace the fluorescent tubes, unscrew and remove the glass fixings resting against the glass plate (Crosstip screwdriver, size 2). Then lift the plate from the cassette. Rotate the tubes by 90° and pull them out of their holders. Fix the glass plate and then screw in the glass fixings.

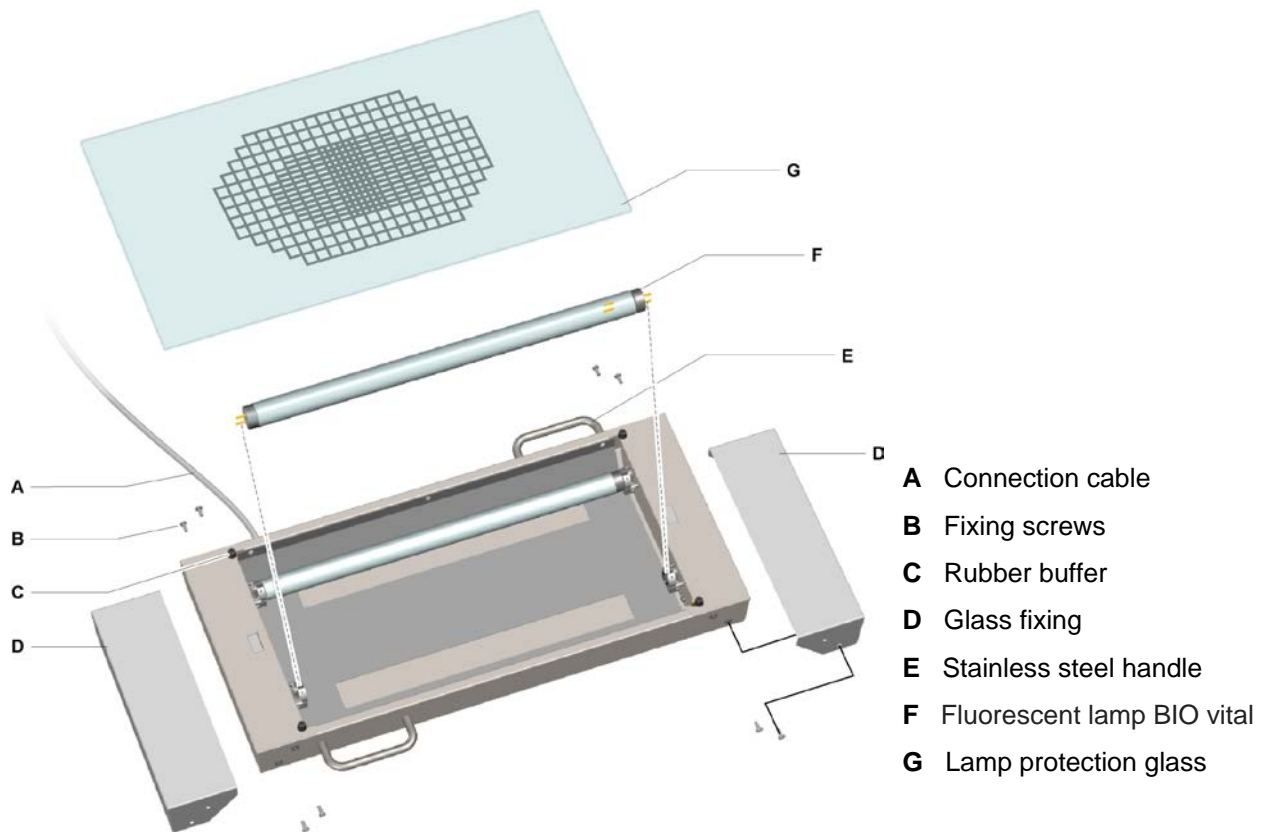



Figure 22: Replacing the fluorescent tubes



Always replace both fluorescent tubes of a light cassette together. Otherwise, homogeneity of light intensity cannot be ensured.

20.3 Cleaning and decontamination

Clean the cabinet after each use to avoid potential corrosion damage by ingredients of the test material.

	<div style="background-color: red; color: white; text-align: center; padding: 5px;">! DANGER</div> <p>Electrical hazard.</p> <p>Danger of death.</p> <ul style="list-style-type: none"> ⊘ Do NOT spill water or cleaning agents over the inner and outer surfaces. ➤ Before cleaning, turn off the cabinet at the main power switch and disconnect the power plug. ➤ Completely dry the appliance before turning it on again.
---	---

20.3.1 Cleaning

Disconnect the cabinet from the power supply before cleaning. Disconnect the power plug.

	The interior of the cabinet must be kept clean. Thoroughly remove any residues of test material.
---	--

Wipe the surfaces with a moistened towel. In addition, you can use the following cleaning agents:

Exterior surfaces inner chamber racks door gaskets	Standard commercial cleaning detergents free from acid or halides. Alcohol-based solutions. We recommend using the neutral cleaning agent Art. No. 1002-0016.
Instrument panel	Standard commercial cleaning detergents free from acid or halides. We recommend using the neutral cleaning agent Art. No. 1002-0016.
Zinc coated hinge parts rear cabinet wall	Standard commercial cleaning detergents free from acid or halides. Do NOT use a neutral cleaning agent on zinc coated surfaces.

Do not use cleaning agents that may cause a hazard due to reaction with components of the device or the charging material. If there is doubt regarding the suitability of cleaning products, please contact your local Datacolor service representative.

	<p>We recommend using the neutral cleaning agent Art. No. 1002-0016 for a thorough cleaning.</p> <p>Any corrosive damage that may arise following use of other cleaning agents is excluded from liability by the manufacturer.</p> <p>Any corrosive damage caused by a lack of cleaning, is excluded from liability by the manufacturer.</p>
--	--

	<p style="text-align: center;">CAUTION</p> <p>Danger of corrosion.</p> <p>Damage to the cabinet.</p> <ul style="list-style-type: none"> ∅ Do NOT use acidic or chlorine cleaning detergents. ∅ Do NOT use a neutral cleaning agent on other kind of surfaces e.g., the zinc coated hinge parts or the rear cabinet wall.
---	---

	<p>For surface protection, perform cleaning as quickly as possible. After cleaning completely remove cleaning agents from the surfaces with a moistened towel. Let the cabinet dry.</p>
---	---





	<p>Soapsuds may contain chlorides and must therefore NOT be used for cleaning.</p>
---	--

	<p>With every cleaning method, always use adequate personal safety controls.</p>
---	--

Following cleaning, leave the cabinet door open or remove the access port plugs.

	<p>The neutral cleaning agent may cause health problems in contact with skin and if ingested. Follow the operating instructions and safety hints labeled on the bottle of the neutral cleaning agent.</p>
---	--

Recommended precautions: To protect the eyes use sealed protective goggles. Suitable protective gloves with full contact: butyl or nitrile rubber, penetration time >480 minutes.

	<table border="1"> <tr> <td colspan="2" data-bbox="536 864 1479 943" style="background-color: yellow; text-align: center;">  CAUTION </td> </tr> <tr> <td colspan="2" data-bbox="536 943 1479 987"> <p>Contact with skin, ingestion.</p> </td> </tr> <tr> <td colspan="2" data-bbox="536 987 1479 1032"> <p>Skin and eye damage due to chemical burns.</p> </td> </tr> <tr> <td colspan="2" data-bbox="536 1032 1479 1077"> <p>∅ Do not ingest. Keep away from food and beverages.</p> </td> </tr> <tr> <td colspan="2" data-bbox="536 1077 1479 1122"> <p>∅ Do NOT empty into drains.</p> </td> </tr> <tr> <td colspan="2" data-bbox="536 1122 1479 1167"> <p>➤ Wear protective gloves and goggles.</p> </td> </tr> <tr> <td colspan="2" data-bbox="536 1167 1479 1211"> <p>➤ Avoid skin contact.</p> </td> </tr> </table>	 CAUTION		<p>Contact with skin, ingestion.</p>		<p>Skin and eye damage due to chemical burns.</p>		<p>∅ Do not ingest. Keep away from food and beverages.</p>		<p>∅ Do NOT empty into drains.</p>		<p>➤ Wear protective gloves and goggles.</p>		<p>➤ Avoid skin contact.</p>	
 CAUTION															
<p>Contact with skin, ingestion.</p>															
<p>Skin and eye damage due to chemical burns.</p>															
<p>∅ Do not ingest. Keep away from food and beverages.</p>															
<p>∅ Do NOT empty into drains.</p>															
<p>➤ Wear protective gloves and goggles.</p>															
<p>➤ Avoid skin contact.</p>															

20.3.2 Decontamination

The operator must ensure that proper decontamination is performed in case a contamination of the cabinet by hazardous substances has occurred.

Disconnect the cabinet from the power supply prior to chemical decontamination. Pull the power plug.

Do not use decontamination agents that may cause a hazard due to reaction with components of the device or the charging material. If there is doubt regarding the suitability of cleaning products, please contact your local Datacolor service representative.

You can use the following disinfectants:

Inner chamber	Standard commercial surface disinfectants free from acid or halides. Alcohol-based solutions. We recommend using the disinfectant spray Art. No. 1002-0022.
---------------	---

	For chemical disinfection, we recommend using the disinfectant spray Art. No. 1002-0022. Any corrosive damage that may arise following use of other disinfectants is excluded from liability by the manufacturer.
---	--





	With every decontamination method, always use adequate personal safety controls.
---	--

In case of contamination of the interior by biologically or chemically hazardous material, there are two possible procedures depending on the type of contamination and charging material:

1. Spray the inner chamber with an appropriate disinfectant.
Before start-up, the cabinet must be absolutely dry and ventilated, as explosive gases may form during the decontamination process.
2. If necessary, have strongly contaminated inner chamber parts removed by an engineer for cleaning, or have them exchanged. Sterilize the inner chamber parts in a sterilizer or autoclave.

	In case of eye contact, the disinfectant spray may cause eye damage due to chemical burns. Follow the operating instructions and safety hints labeled on the bottle of the disinfectant spray.
---	--

Recommended precautions: To protect the eyes use sealed protective goggles.

 	 CAUTION
 	<p>Eye contact.</p> <p>Eye damage due to chemical burns.</p> <ul style="list-style-type: none"> ⊘ Do NOT empty into drains. ➤ Wear protective goggles.

	After using the disinfectant spray, allow the cabinet to dry thoroughly, and aerate it sufficiently.
---	--

21. Disposal

21.1 Disposal of the transport packing

Packing element	Material	Disposal
Straps to fix packing on pallet	Plastic	Plastic recycling
Wooden transport box (option) with metal screws	Non-wood (compressed match-wood, IPPC standard)	Wood recycling
	Metal	Metal recycling
Pallet with foamed plastic stuffing	Solid wood (IPPC standard)	Wood recycling
	PE foam	Plastic recycling
Transport box with metal clamps	Cardboard	Paper recycling
	Metal	Metal recycling
Top cover	Cardboard	Paper recycling
Edge protection	Styropor® or PE foam	Plastic recycling
Protection of doors and racks	PE foam	Plastic recycling
Bag for operating manual	PE foil	Plastic recycling
Insulating air cushion foil (packing of optional accessories)	PE foil	Plastic recycling

If recycling is not possible, all packing parts can also be disposed of with normal waste.

21.2 Decommissioning

- Turn off the cabinet at the main power switch (1) and disconnect it from the power supply.
- Close the tap used for the water supply.
- Turn off humidity control (chap. 6.3).
- Remove the water installation.
- Temporal decommissioning: See indications for appropriate storage, chap. 3.3.
- Final decommissioning: Dispose of the cabinet as described in chap. 21.3 and 21.4.

21.3 Disposal of the cabinet in the member states of the EU

According to Annex I of Directive 2012/19/EU of the European Parliament and of the Council on waste electrical and electronic equipment (WEEE), Datacolor CONDITIONER™ cabinets are classified as “monitoring and control instruments” (category 9) only intended for professional use“. They must not be disposed of at public collecting points.

The cabinets bear the symbol for the marking of electrical and electronic equipment manufactured / placed on the market in the EU after 13 August 2005 and be disposed of in separate collection according to the Directive 2012/19/EU on waste electrical and electronic equipment (WEEE). WEEE marking: crossed-out wheeled bin with solid bar under.

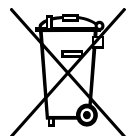





At the end of the device's service life, notify the distributor who sold you the device, who will take back and dispose of the cabinet according to the Directive 2012/19/EU on waste electrical and electronic equipment (WEEE).

	CAUTION
	<p>Violation against existing law.</p> <ul style="list-style-type: none"> ⊘ Do NOT dispose of the cabinet at public collecting points. ➤ Have the cabinet disposed of professionally at a recycling company that is certified according to conversion of the Directive 2012/19/EU into national law.

Certified companies disassemble waste (used) equipment in primary substances for recycling according to Directive 2012/19/EU. The devices must be free from toxic, infectious or radioactive substances in order to eliminate any health hazards to the employees of the recycling companies.

	<p>Prior to handing the cabinet over to a recycling company, it is the user's responsibility that it is free from toxic, infectious or radioactive substances.</p> <ul style="list-style-type: none"> • Prior to disposal, clean all introduced or residual toxic substances from the cabinet. • Prior to disposal, disinfect the cabinet from all sources of infection. Be aware that sources of infection may also be located outside the inner chamber. • If you cannot safely remove all sources of infection and toxic substances from the cabinet, dispose of it as special waste according to national law.
---	---

	<table border="1"> <tr> <td colspan="2" data-bbox="384 622 1477 701" style="background-color: #FFA500; text-align: center;">  WARNING </td> </tr> <tr> <td colspan="2" data-bbox="384 701 1477 741"> <p>Contamination of the device with toxic, infectious or radioactive substances.</p> </td> </tr> <tr> <td colspan="2" data-bbox="384 741 1477 786"> <p>Danger of intoxication.</p> </td> </tr> <tr> <td colspan="2" data-bbox="384 786 1477 831"> <p>Danger of infection.</p> </td> </tr> <tr> <td data-bbox="384 831 416 1070"> <ul style="list-style-type: none"> ⊗ NEVER take a cabinet contaminated with toxic substances or sources of infection for recycling according to Directive 2012/19/EU. ➤ Prior to disposal, remove all toxic substances and sources of infection from the cabinet. ➤ A cabinet from which all toxic substances or sources of infection cannot be safely removed must be considered as "special" waste according to national law. Dispose of it accordingly. </td> <td data-bbox="416 831 1477 1070"></td> </tr> </table>	 WARNING		<p>Contamination of the device with toxic, infectious or radioactive substances.</p>		<p>Danger of intoxication.</p>		<p>Danger of infection.</p>		<ul style="list-style-type: none"> ⊗ NEVER take a cabinet contaminated with toxic substances or sources of infection for recycling according to Directive 2012/19/EU. ➤ Prior to disposal, remove all toxic substances and sources of infection from the cabinet. ➤ A cabinet from which all toxic substances or sources of infection cannot be safely removed must be considered as "special" waste according to national law. Dispose of it accordingly. 	
 WARNING											
<p>Contamination of the device with toxic, infectious or radioactive substances.</p>											
<p>Danger of intoxication.</p>											
<p>Danger of infection.</p>											
<ul style="list-style-type: none"> ⊗ NEVER take a cabinet contaminated with toxic substances or sources of infection for recycling according to Directive 2012/19/EU. ➤ Prior to disposal, remove all toxic substances and sources of infection from the cabinet. ➤ A cabinet from which all toxic substances or sources of infection cannot be safely removed must be considered as "special" waste according to national law. Dispose of it accordingly. 											

The refrigerant used R 134A (1,1,1,2-tetrafluoroethane) is not inflammable at ambient pressure. It must not escape into the environment. In Europe, recovery of the refrigerant R 134A (1300) is mandatory according to regulation No. 842/2006/EC. Ensure the compliance with the applicable legal requirements regarding qualification of staff, disposal, and documentation.

21.4 Disposal of the cabinet in non-member states of the EU

	<table border="1"> <tr> <td colspan="2" data-bbox="384 1375 1477 1440" style="background-color: #FFFF00; text-align: center;"> CAUTION </td> </tr> <tr> <td colspan="2" data-bbox="384 1440 1477 1480"> <p>Alteration of the environment.</p> </td> </tr> <tr> <td data-bbox="384 1480 416 1680"> <ul style="list-style-type: none"> ➤ Follow the statutory regulations for appropriate, environmentally friendly disposal. </td> <td data-bbox="416 1480 1477 1680"></td> </tr> </table>	CAUTION		<p>Alteration of the environment.</p>		<ul style="list-style-type: none"> ➤ Follow the statutory regulations for appropriate, environmentally friendly disposal. 	
CAUTION							
<p>Alteration of the environment.</p>							
<ul style="list-style-type: none"> ➤ Follow the statutory regulations for appropriate, environmentally friendly disposal. 							

The main board of the cabinet includes a lithium cell. Please dispose of it according to national regulations.

The refrigerant used R 134A (1,1,1,2-tetrafluoroethane) is not inflammable at ambient pressure. It must not escape into the environment. In Europe, recovery of the refrigerant R 134A (1300) is mandatory according to regulation No. 842/2006/EC. Ensure the compliance with the applicable legal requirements regarding qualification of staff, disposal, and documentation.

22. Troubleshooting

Fault description	Possible cause	Required measures
General		
Cabinet without function.	No power supply.	Check connection to power supply.
	Wrong voltage.	Check power supply for correct voltage (chap. 4.7).
	Cabinet fuse has responded.	Check cabinet fuse and replace it if appropriate. If it responds again, contact your local Datacolor service representative.
	Controller defective. Nominal temperature exceeded by 10° due to cabinet failure. Over temperature protective device (class 1) responds.	Contact your local Datacolor service representative.
Heating		
Cabinet heating permanently, set-point not maintained.	Controller defective.	Contact your local Datacolor service representative.
	Semiconductor relay defective.	
	Controller not well adjusted, or adjustment interval exceeded.	Calibrate and adjust controller.
Cabinet doesn't heat up.	Pt 100 sensor defective.	Contact your local Datacolor service representative.
	Heating element defective.	
	Semiconductor relay defective	
Cabinet doesn't heat up when turned on. Safety controller responds.	Inner chamber temperature has reached the safety controller setpoint. Safety controller set too low.	Acknowledge the alarm on the controller. Check temperature setpoint setting. If appropriate, select suitable safety controller setpoint (chap. 12.2).
	Safety controller (chap. 12.2) defective.	Contact your local Datacolor service representative.
Refrigerating performance		
Low or no refrigerating performance.	Ambient temperature > 25 °C / 77 °F (chap.3.4).	Select cooler place of installation.
	Combination of temperature/humidity values not in the optimum range (see temperature humidity diagram, Figure 20).	Select combination of temperature/humidity values in the optimum range (chap. 17).
	Compressor not turned on.	Contact your local Datacolor service representative.
	Electro-valves defective.	
	No or not enough refrigerant.	
Too much external heat load.	Reduce heat load.	
Humidity		
Humidity fluctuation: Control accuracy of ± 3 % r.F. is not reached.	Door gasket defective.	Replace door gasket.
	Door opened very frequently.	Open doors less frequently.
Humidity fluctuation, together with temperature fluctuation > 1 °C with a set-point ca. 3 °C above ambient temperature.	Place of installation too hot.	Select cooler place of installation or contact your local Datacolor service representative.
Low or no dehumidification.	Capillary tube blocked	Contact your local Datacolor service representative.
	Not enough refrigerant.	
	Humidity control turned off.	Turn on humidity control (chap. 6.3, 7.3).

Fault description	Possible cause	Required measures
Humidity (continued)		
Icing at the evaporator plates.	Set-point was too long below ambient temperature.	Defrost the unit (chap. 18).
Condensation at the walls of the inner chamber.	Combination of temperature/humidity values not in the optimum range (see temperature humidity diagram, Figure 20)	Select combination of temperature/humidity values in the optimum range (chap. 17).
	Set-point was too long below ambient temperature, icing in the preheating chamber.	Defrost the cabinet (chap. 18)
Low humidity and temp. accuracy.	Fan speed has been reduced.	Set fan speed to 100%.
Controller		
No cabinet function (dark display).	Display in standby mode.	Press on touchscreen.
	Main power switch turned off.	Turn on the main power switch.
Menu functions not available.	Menu functions not available with current authorization level.	Log in with the required higher authorization.
No access to controller	Password incorrect.	Contact your local Datacolor service representative.
Chart recorder function: measured-value memory cleared; information lost.	New setting of storage rate or scaling (minimum and/or maximum) (chap. 16.2).	Change the storage rate or scaling ONLY if the previously registered data are no longer required.
Controller does not equilibrate to setpoints entered in Fixed value operation mode	Controller is not in Fixed value operation mode.	Change to Fixed value operation mode.
Controller does not equilibrate to program set-points.	Controller is not in program operation mode, or program delay time is running.	Start the program again. If appropriate, wait for the program delay time.
Program duration longer than programmed.	Tolerances have been programmed.	For rapid transition phases, do NOT program tolerance limits in order to permit maximum heating, refrigerating, or humidification speed.
Program keeps the last program setpoint constant while in setting "ramp".	Program line with setting "ramp" is incomplete.	When programming with setting "ramp", define the end value of the desired cycle by adding an additional section with a section time of at least one second.
Ramp temperature transitions are only realized as steps.	Setting "step" has been selected.	Select setting "ramp".
Humidity alarm when operating without water connection.	Humidity control turned on.	Turn off humidity control (chap. 6.3).
Acknowledging the alarm does not cancel the alarm state.	Cause of alarm persists.	Remove cause of alarm. If the alarm state continues, contact your local Datacolor service representative.
Alarm message: ---- or <<<< or >>>>	Sensor rupture between sensor and controller or Pt 100 sensor defective.	Contact your local Datacolor service representative.
	Short-circuit.	
Miscellaneous		
Fluorescent tube does not illuminate.	Defective fluorescent tube.	Replace the fluorescent tubes.
Impaired valve function of hose burst protection.	Calcification.	Remove calcifications by citric acid or acetic acid solutions (chap. 4.3.1). Have a plumber inspect the valve.



Only qualified service personnel authorized by Datacolor representative must perform repair. Repaired cabinets must comply with the manufacturer's quality standards.

23. Technical description

23.1 Factory calibration and adjustment

This cabinet was calibrated and adjusted in the factory. Calibration and adjustment were performed using standardized test instructions, according to the QM DIN EN ISO 9001 system applied by the manufacturer (certified since December 1996 by TÜV CERT). All test equipment used is subject to the administration of measurement and test equipment that is also a constituent part of the manufacturer's QM DIN EN ISO 9001 systems. They are controlled and calibrated to a DKD-Standard at regular intervals.



Repeated calibrations are recommended in periods of 12 months.

23.2 Over current protection

The devices are equipped with an internal fuse not accessible from outside. If this fuse is blown, please contact an electronic engineer or your local Datacolor service representative.

23.3 Definition of usable volume

The usable volume illustrated below is calculated as follows:

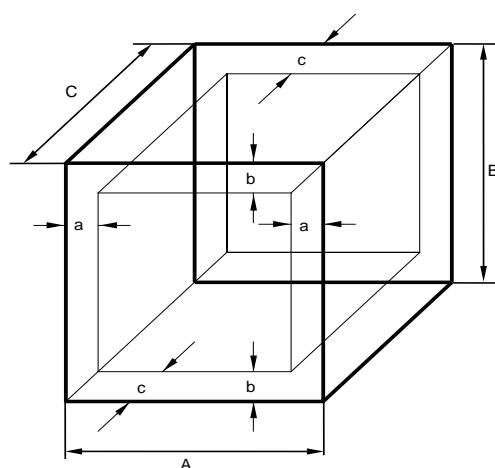

A, B, C = internal dimensions (W, H, D)

a, b, c = distance to wall

$$a = 0.1 * A$$

$$b = 0.1 * B$$

$$c = 0.1 * C$$

$$V_{USE} = (A - 2 * a) * (B - 2 * b) * (C - 2 * c)$$

Figure 23: Determination of the usable volume

The technical data refers to the defined usable volume.



Do NOT place samples outside this usable volume.

Do NOT load this volume by more than half to enable sufficient airflow inside the cabinet.

Do NOT divide the usable volume into separate parts with large area samples.

Do NOT place samples too close to each other in order to permit circulation between them and thus obtain a homogenous distribution of temperature and humidity.

23.4 Technical Data

		Cabinet without lights	Cabinet with lights
Exterior dimensions			
Width, net	mm / inch	880 / 34.65	880 / 34.65
Height, gross (incl. feet/castors)	mm / inch	1050 / 41.34	1050 / 41.34
Depth, net	mm / inch	650 / 25.59	650 / 25.59
Depth, gross (including door handle, I-triangle, connection and 30 mm for cable)	mm / inch	730 / 28.74	730 / 28.74
Wall clearance rear (minimum) (spacer)	mm / inch	100 / 3.94	100 / 3.94
Wall clearance side (minimum)	mm / inch	160 / 6.29	160 / 6.29
Doors			
Quantity of doors		1	1
Quantity of inner glass doors		1	1
Interior dimensions			
Width	mm / inch	600 / 23.62	600 / 23.62
Height	mm / inch	483 / 19.02	483 / 19.02
Depth	mm / inch	351 / 13.82	351 / 13.82
Interior volume	l / cu.ft.	102 / 3.6	102 / 3.6
Steam space volume	l / cu.ft.	156 / 5.5	156 / 5.5
Racks			
Quantity of racks (regular)		2	2
Quantity of racks (max.),		5	2
Quantity of light cassettes		---	2
Maximum load per rack	kg / lbs.	30 / 66	30 / 66
Maximum permitted total load	kg / lbs.	100 / 220	100 / 220
Weight			
Weight (empty)	kg / lbs.	129 / 284	140 / 309
Climatic data (with humidity) *			
Temperature range	°C / °F	+10 to +70 50 to 158	+10 to +50 50 to 122
Temperature fluctuation at 21 °C / 69.8 °F and 65% r.H.	± K	0.2	0.2
Temperature uniformity (variation) at 21 °C / 69.8 °F and 65% r.H.	± K	0.2	0.2
Humidity range	% r.H.	10 to 80	10 to 70
Humidity fluctuation at 21 °C / 69.8 °F and 65% r.H.	± % r.H.	≤ 2.0	≤ 2.0
Recovery time after doors were open for 30 sec. at 21 °C / 69.8 °F and 65% r.H.	minutes	6	6
Electrical data			
IP system of protection acc. to EN 60529		20	20
Nominal voltage (+/-10%)	at 50 Hz power frequency	V	200-240
	at 60 Hz power frequency	V	200-240
Current type		2~	2~
Power plug	NEMA	6-20P	6-20P
Nominal power	kW	2.00	2.00
Nominal current	A	8.4	8.4
Installation category acc. to IEC 61010-1		II	II
Pollution degree acc. to IEC 61010-1		2	2
Over-current release category B, 2 poles	Amp	16	16

		Cabinet without lights	Cabinet with lights
Illumination data per light cassette			
Light intensity, setting 100%	Lux	---	4500
Environment-specific data			
Noise level (mean value)	dB (A)	52	52
Energy consumption at 21 °C / 69.8 °F and 65% r.H. without illumination	Wh/h	≤ 500	≤ 500
Energy consumption at 21 °C / 69.8 °F and 65% r.H. with illumination	Wh/h	---	≤ 580
Filling weight of refrigerant R 134A (GWP 1300)	kg	0,180	0,180

* Cabinet with lights: All climatic data established with illumination

Illumination data: Average value, measured at +22 °C +/- 3 °C / 71.6 °F +/- 5.4 °F with a spherical sensor (+/-10%) by 12 cm / 4.7 in below the light cassette.

All technical data is specified for unloaded cabinets with standard equipment at an ambient temperature of +22 °C +/- 3°C / 71.6 °F +/- 5.4 °F and a power supply voltage fluctuation of +/-10%. Technical data is determined in accordance to BINDER factory standard Part 2:2015 and DIN 12880:2007.

All indications are average values, typical for cabinets produced in series. We reserve the right to change technical specifications at any time.

	If the cabinet is fully loaded, the specified heating up and cooling down times may vary according to the load.
---	---

	Bringing a source of humidity into the inner chamber will affect the minimum humidity specification and may affect the humidity accuracy.
---	---

23.5 Equipment

	To operate the cabinet, use only original Datacolor accessories or accessories / components from third-party suppliers authorized by Datacolor. The user is responsible for any risk arising from using unauthorized accessories.
---	---

Regular equipment
Microprocessor display program controller with 2-channel technology for temperature and humidity
Ethernet interface for computer communication
Electronic safety controller (temperature safety device) class 3.1 acc. to DIN 12880:2007
Inner glass door with gasket
DCT™ refrigerating system with refrigerant R134a
Microprocessor controlled humidifying and dehumidifying system *) (humidity range, see diagram)
2 racks, stainless steel
Access port 30 mm with silicone plug
Illumination system: "Bio Vital" fluorescent tubes, 2 light cassettes with 2 fluorescent tubes each

*) A water supply (1 to 10 bar) is necessary for the installation of the humidifying and de-humidifying system (chap. 4.3). If no suitable house water connection is available, you can manually supply water by filling a freshwater can (option, chap. 4.5). Furthermore, a water drain in a max. distance of 3 meters / 9.8 ft. and a max. height of 1 meter / 3.3 ft. is required (chap. 4.2).

Optional equipment	Art. no.
Additional rack, stainless steel	6004-0112
Set of two "Bio Vital" fluorescent tubes, set for 1 light cassette	8012-1812
Light cassette 115 complete	8009-0951
External freshwater and wastewater cans (20 liters / 0.71 cu.ft. each)	8012-0643
"BINDER Pure Aqua Service" water treatment system	8012-0759
Exchange cartridge for BINDER Pure Aqua Service	6011-0165
Voltage changer for operation at 120 Volt	8009-0954
Water conductivity measuring device	5016-0048
Neutral cleaning agent, 1 kg	1002-0016

23.6 Spare parts (extract)

	The manufacturer is responsible for the safety features of the cabinet only, provided skilled electricians or qualified personnel authorized by Datacolor perform all maintenance and repair, and if components relating to cabinet safety are replaced in the event of failure with original spare parts. The user is responsible for any risks arising from using unauthorized accessories/components.
---	--

Description	Art. no.
Door gasket for glass door	6005-0204
Door gasket silicone (kettle)	6005-0207
Door gasket silicone (outer door)	6005-0203
Plug for silicon access port d30	6016-0035
Set of two "Bio Vital" fluorescent tubes, set for 1 light cassette	8012-1812

For information on components not listed here, please contact your local Datacolor service representative.

23.7 Dimensions size 115

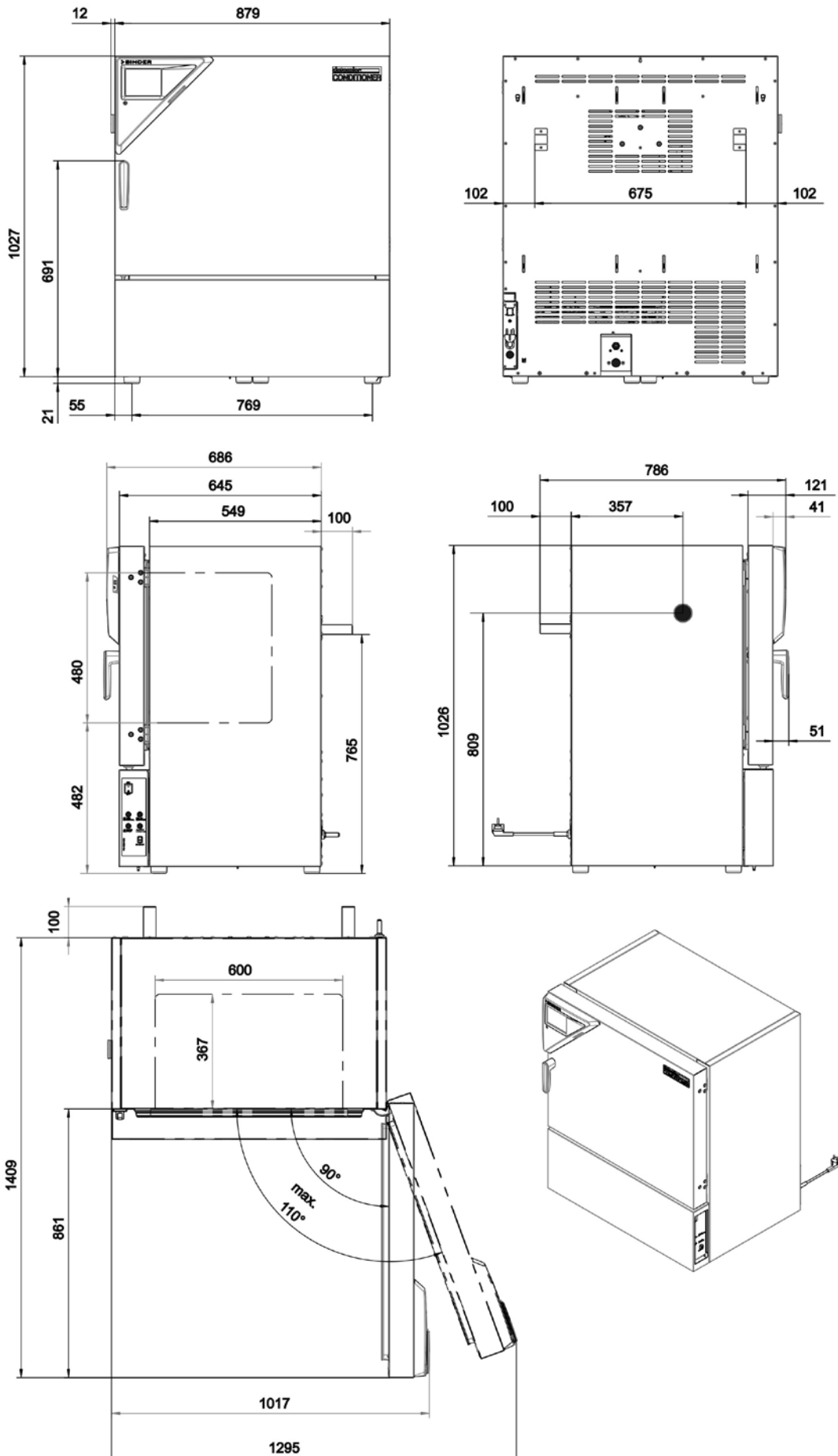

24. EU Declaration of Conformity



CE EU-Konformitätserklärung / EU Declaration of Conformity / Déclaration de conformité
UE / Declaración de conformidad UE

Hersteller / Manufacturer / Fabricant / Fabricante	BINDER GmbH
Anschrift / Address / Adresse / Dirección	Im Mittleren Ösch 5, 78532 Tuttlingen, Germany
Produkt / Product / Produit / Producto	Probenkonditionierschrank Sample conditioning cabinet Chambre de conditionnement d'échantillons Cámara de acondicionamiento de muestras
Typenbezeichnung / Type / Type / Tipo	Datacolor CONDITIONER™

Die oben beschriebenen Maschinen sind konform mit folgenden EG/EU-Richtlinien (gemäß Veröffentlichung im Amtsblatt der europäischen Kommission):

The machines described above are in conformity with the following EC/EU Directives (as published in the Official Journal of the European Union):

Les machines décrites ci-dessus sont conformes aux directives CE/UE suivantes (selon leur publication dans le Journal officiel de l'Union européenne):

La máquina descrita arriba cumple con las siguientes directivas de la CE/UE (publicados en el Diario oficial de la Unión Europea):

- **2006/42/EC**
Maschinenrichtlinie 2006/42/EG / Machinery directive 2006/42/EC / Directive Machines 2006/42/EC / Directiva 2006/42/CE (Máquinas) / Direttiva macchine 2006/42/CE / Директива о машинах 2006/42/EC
- **2014/30/EU**
EMV-Richtlinie 2014/30/EU / EMC Directive 2014/30/EU / Directive CEM 2014/30/UE / Directiva CEM 2014/30/UE / Direttiva EMC 2014/30/UE / Директива ЭМС 2014/30/EU
- **2011/65/EU**
RoHS-Richtlinie 2011/65/EU / RoHS Directive 2011/65/EU / Directive RoHS 2011/65/UE / Directiva RoHS 2011/65/UE / Direttiva RoHS 2011/65/UE / Директива RoHS 2011/65/EU

Die oben beschriebenen Maschinen entsprechen aufgrund ihrer Konzipierung und Bauart sowie in der von uns in Verkehr gebrachten Ausführung den einschlägigen grundlegenden Sicherheits- und Gesundheitsanforderungen der genannten EG/EU-Richtlinien.

The machines described above are conform to the mentioned EC/EU directives in regard to the relevant safety and health demands due to their conception and style of construction as well as to the version put onto market by us.

Les machines décrites ci-dessus correspondent aux demandes de sécurité et de santé des directives citées de la CE/UE due à leur conception et construction et dans la réalisation mise sur le marché par nous.

Las máquinas descritas arriba se corresponden con los requisitos básicos pertinentes de seguridad y salud de las citadas directivas de la CE/UE debido a su concepción y fabricación, así como a la realización llevada a cabo por nosotros.

Die oben beschriebenen Maschinen tragen entsprechend die Kennzeichnung CE.

The machines described above, corresponding to this, bear the CE-mark.

Les machines décrits ci-dessus, en correspondance, portent l'indication CE.

Las máquinas descritas arriba, en conformidad, llevan la indicación CE.

1 / 2

BINDER GmbH Postfach 102 D-78502 Tuttlingen Address: BINDER GmbH Im Mittleren Ösch 5 78532 Tuttlingen Germany
 Contact: Phone: +49 (0) 74 62 / 20 05 - 0 | Fax: +49 (0) 74 62 / 20 05 - 100 | info@binder-world.com | www.binder-world.com
 Managing Director: Dipl.-Ing. Peter M. Binder | District court Stuttgart, HRB 727150 | Company head office: Tuttlingen Germany
 Payment Details: Kreissparkasse Tuttlingen Account no.: 2266 BAN: 643 500 70 | IBAN-Code: DE05643 500700 000002266 | SWIFT-Code: SOLA DE S1TUT
 S-Account no. 2202 611 55 | IBAN-Code: DE7464350070 0220 261155 | SWIFT-Code: SOLA DE S1TUT
 Deutsche Bank Tuttlingen Account no.: 2 138 709 BAN: 653 700 75 | IBAN-Code: DE56653 70075 0213870900 | SWIFT-Code: DEUT DE SS603
 Recycling of old equipment according to WEEE-Reg.-no. DE 37004983



Die oben beschriebenen Maschinen sind konform mit folgenden harmonisierten Normen:
 The machines described above are in conformity with the following harmonized standards:
 Les machines décrits ci-dessus sont conformes aux normes harmonisées suivantes:
 Las maquinas descritas arriba cumplen con las siguientes normas:

Sicherheit / Safety / Sécurité / Seguridad
<ul style="list-style-type: none"> • EN ISO 12100:2010 + Corr. 1:2011 • EN ISO 13732-1:2008 • EN 60204-1:2006 + A1:2009 + Corr. :2010
EMV / EMC / CEM / CEM
<ul style="list-style-type: none"> • EN 61326-1:2013
RoHS
<ul style="list-style-type: none"> • EN 50581:2012

78532 Tuttlingen, 03.07.2017
 BINDER GmbH



P. M. Binder
 Geschäftsführender Gesellschafter
 Managing Director
 Directeur général
 Director general



J. Bollaender
 Leiter F & E und Dokumentationsbevollmächtigter
 Director R & D and documentation representative
 Chef de service R&D et autorisé de documentation
 Responsable I & D y representante de documentación

2 / 2

BINDER GmbH Postfach 102 D-78502 Tuttlingen **Address:** BINDER GmbH Im Mittleren Osch 5 78532 Tuttlingen Germany
Contact: Phone: +49 (0) 74 62 / 20 05 - 0 | Fax: +49 (0) 74 62 / 20 05 - 100 | info@binder-world.com | www.binder-world.com
Managing Director: Dipl.-Ing. Peter M. Binder | District court Stuttgart, HRB 727150 | Company head office: Tuttlingen Germany
Payment Details: Kreissparkasse Tuttlingen Account no.: 2266 | BAN: 643 500 70 | IBAN-Code: DE05643 500700 000002266 | SWIFT-Code: SOLA DE S1TUT
 \$-Account no. 2202 611 55 | IBAN-Code: DE7464350070 0220 261155 | SWIFT-Code: SOLA DE S1TUT
 Deutsche Bank Tuttlingen Account no.: 2 138 709 | BAN: 653 700 75 | IBAN-Code: DE56653 70075 0213870900 | SWIFT-Code: DEUT DE SS603
 Recycling of old equipment according to WEEE-Reg.-no. DE 37004983

